

<b>Contents</b>			
Contents	1	Group 7 – The Halogens	20
Topic 1 – The nature of substances and chemical reactions	2	Identifying hydrogen gas	22
Atoms	2	Identifying Ions	23
Representing atoms	3	Group 0 – The Noble Gases	24
Elements	3	Topic 3 – Water	25
Compounds	3	What’s in our water?	25
Using chemical formulae	4	Sustainable water supply	25
Chemical Reactions	4	Treatment of public water	26
Ionic compounds	5	Desalination of sea water	26
Isotopes	6	Fluoridation	27
Relative atomic mass ( $A_r$ )	6	Solubility	28
Relative molecular (formula) mass ( $M_r$ )	6	Hard and soft water	29
Percentage (%) composition of compounds	7	The health benefits of hard water and its negative effects	30
Chemical Equations	7	Topic 4 – The ever-changing Earth	31
Moles	9	Structure of the Earth	31
Calculations	10	Plate Tectonics	31
Mixtures	12	The Atmosphere	33
Chemical reactions	14	Environmental issues	34
Topic 2 - Atomic structure & the Periodic Table	15	Gasses	35
Atoms – recap	15	Topic 5 – Rate of Chemical Change	36
The Periodic Table	16	Rates of Reaction	36
Electronic Structure	18	Collecting Data/Measuring the Reaction	37
Group 1 – The Alkali Metals	19	Particle/Collision Theory	38

## Topic 1 – The nature of substances and chemical reactions

### Atoms

Each atom has **negatively** charged **electrons** orbiting a **positively** charged **nucleus**.

Atoms contain a **nucleus** and **orbits (shells)**.

#### The nucleus

- Contains **protons** and **neutrons**.
- Protons** are **positively (+)** charged.
- Neutrons** are **neutrally (0)** charged (no charge).
- So... overall the nucleus has a **positive** charge.

#### The orbits (shells)

- Contain **electrons**.
- Electrons are **negatively (-)** charged.
- The electrons move around the nucleus in their orbits (shells).
- The electrons are **tiny** but cover a large area in their orbits.

Overall **atoms** have **no charge**. The **number of electrons** *equal* the **number of protons**.

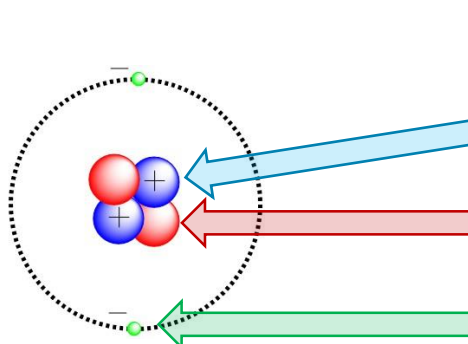

PARTICLE	RELATIVE MASS	CHARGE
<b>Proton</b> - Nucleus	<b>1</b>	<b>+1</b>
<b>Neutron</b> - Nucleus	<b>1</b>	<b>0</b>
<b>Electron</b> - Orbit	<b>0.0005</b>	<b>-1</b>

### Ion

If an atom **gains** or **loses** an electron it becomes an **ion**.

**Gaining** an electron  **Negative ion**

**Losing** an electron  **Positive ion**



#### Symbols

Atoms can be represented by **symbols**. The atoms of each element are represented by a **chemical symbol**. This usually consists of **one or two different letters**, but sometimes three letters are used for newly discovered elements.

*O = oxygen    Na = sodium    C = carbon    Ag = silver    Au = gold    W = tungsten*

The **first letter** in a chemical symbol is always an **UPPERCASE letter**, and the **other letters** are always **lowercase**. So, the symbol for a magnesium atom is Mg and not mg, MG or mG.

## Representing atoms

Mass number

The number of **protons and neutrons** in the nucleus.

Atomic number

The number of **protons** in the nucleus.

**This is also equal to** the number of **electrons** in the orbits.

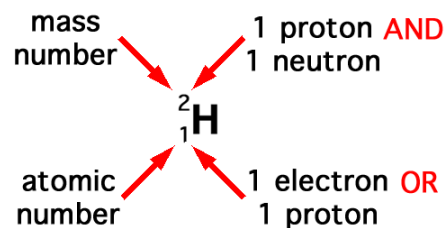

## Elements

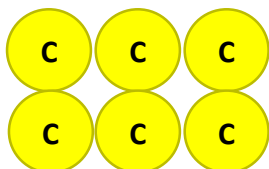

Elements are substances that cannot be broken down into simpler substances by chemical means and are the **basic building blocks of all substances**.

Elements are substances made up of only **one type of atom**. It's the number of **protons** in the nucleus that determines which **type of atom** it is.



Copper wire - All the atoms are copper atoms



Diamond - All the atoms are carbon atoms

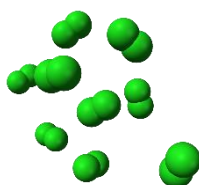

Chlorine gas - All the atoms are chlorine atoms

## Compounds

Substances that contain **two or more** elements joined together chemically.

Compounds have **chemically different properties** to the **elements** that make it.

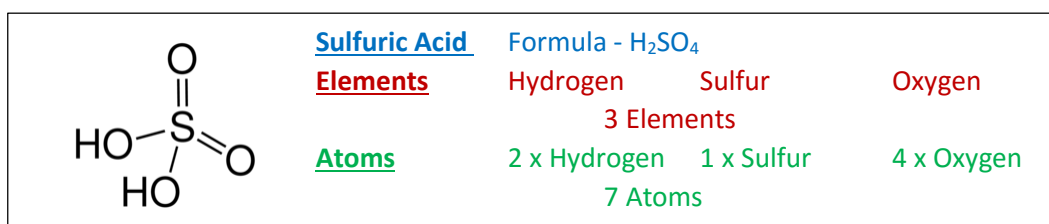
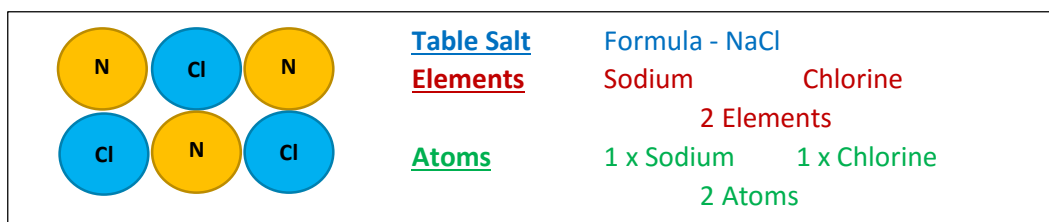
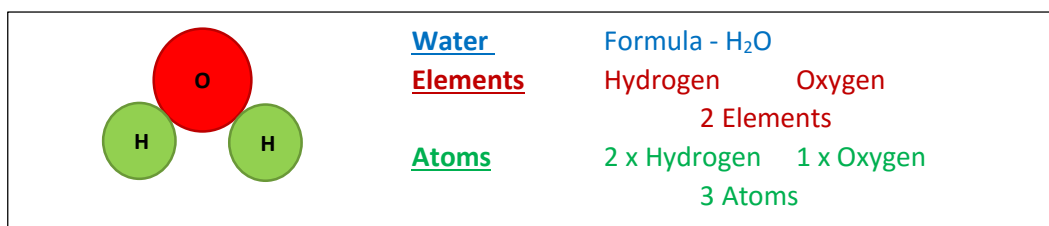

## Using chemical formulae

Compounds are written using a **formula** of the **symbols** of the **elements** in it.

Compound	Formula	No. of elements	No. of atoms
Sodium Chloride	NaCl	2	2 (1 Na, 1 Cl)
Sodium Hydroxide	NaOH	3	3 (1 Na, 1 O, 1 H)
Sodium Oxide	Na <sub>2</sub> O	2	3 (2 Na, 1 O)
Sodium Sulfate	Na <sub>2</sub> SO <sub>4</sub>	3	7 (2 Na, 1 S, 4 O)
Calcium Carbonate	CaCO <sub>3</sub>	3	5 (1 Ca, 1 C, 3 O)

## Worked Example Question

What is the total number of atoms in this formula (NH<sub>4</sub>)<sub>2</sub>SO<sub>4</sub>, ammonium sulfate?

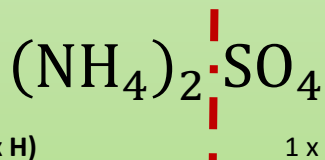

$$2 \times \text{NH}_4 = (2 \times \text{N}) + (2 \times \text{H}_4) = (2 \times \text{N}) + (8 \times \text{H})$$

$$1 \times \text{SO}_4 = (1 \times \text{S}) + (1 \times \text{O}_4) = (1 \times \text{S}) + (4 \times \text{O})$$

$$\text{So... } (2 \times \text{N}) + (8 \times \text{H}) + (1 \times \text{S}) + (4 \times \text{O})$$

$$\text{TOTAL} = 15 \text{ Atoms}$$

## Chemical Reactions

Atoms are **rearranged** during a chemical reaction. *None are created or destroyed.*

Representing simple molecules using a diagram and key

Sometimes it's hard to **visualise** what's happening during a reaction, so it's useful to represent simple molecules using a diagram:

Methane burns in air forming carbon dioxide and water. This reaction is represented by the symbol equation:



It can also be represented by the diagram equation:

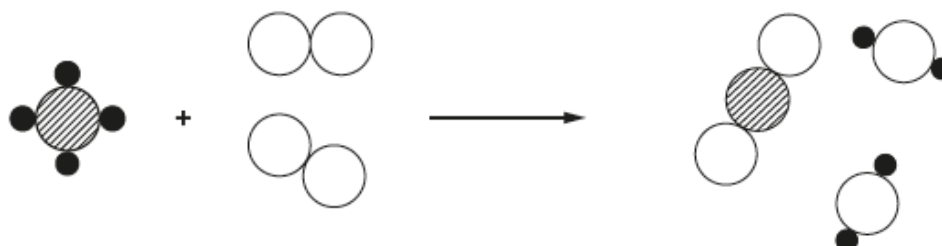

### Ionic compounds

When a chemical reaction takes place, **new bonds are formed**.

**Ionic compounds** form by the **transfer of electrons** from **metal** to **non-metal** atom. Charged particles called **ions** are formed.

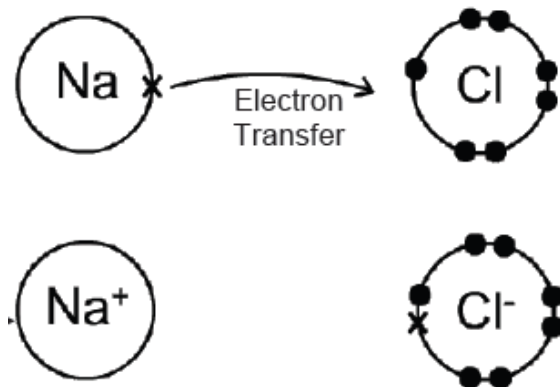

*e.g.* When sodium chloride (NaCl) forms, one electron is transferred from the outer orbit (*shell*) of the **sodium atom** into the outer orbit of the **chlorine atom**.

This will form a **full stable outer orbit** (*shell*) for the **two** particles.

The **sodium atom** becomes a **positive sodium ion (Na<sup>+</sup>)**.

The **chlorine atom** becomes a **negative chloride ion (Cl<sup>-</sup>)**.

It's the strong **electrostatic attraction** between the **two charges** that holds ionic compounds together.

**Overall there is no charge** as the **positive** and **negative** charges cancel.

Using ions to create formulae

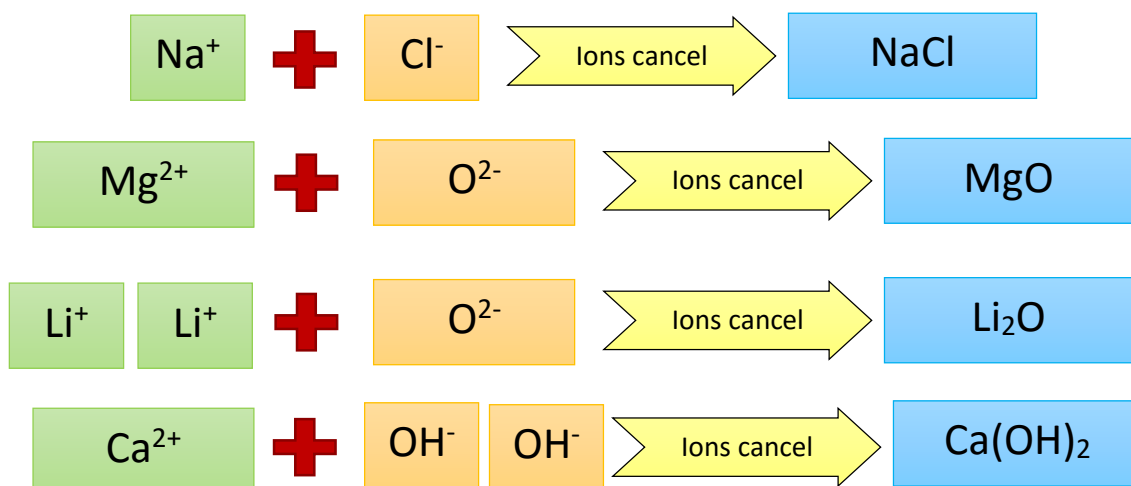

Compounds have completely different properties to their constituent elements

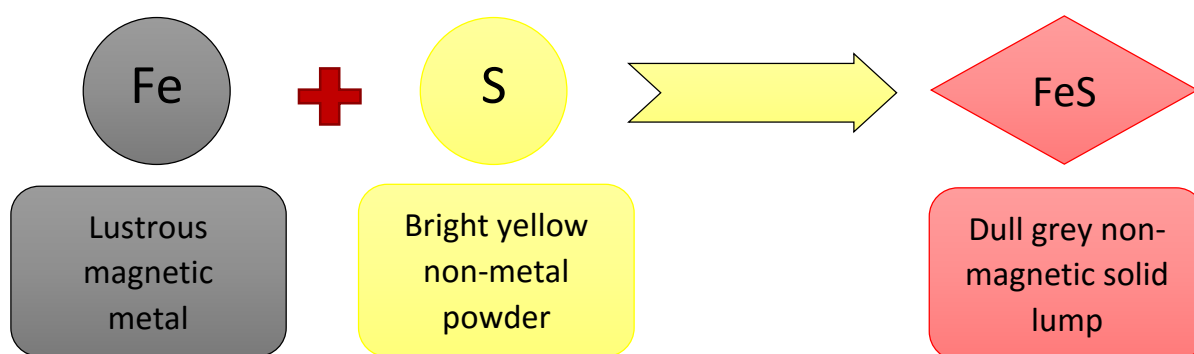

## Isotopes

**Isotopes** are different atomic forms of the **same element**, which have the **same number of protons** (and electrons) but a **different number of neutrons**.

### Three Isotopes of Hydrogen

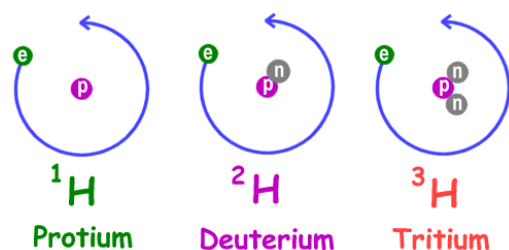

## Isotopes of Carbon

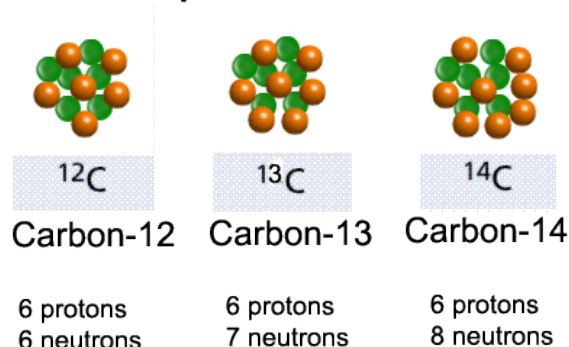

## Relative atomic mass ( $A_r$ )

**Relative atomic mass ( $A_r$ )** uses the **average mass** of the **isotopes** of an element. It has to allow for the **relative mass** of each isotope and its **relative abundance**.

**Relative abundance** means how much there is of **each isotope** compared to the **total amount** of the element in the world.

### Key

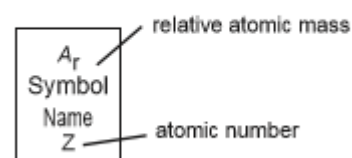

Element	Relative mass of isotope	Relative abundance
Chlorine (Cl)	35	3
	37	1

e.g. This means that there are 2 isotopes of chlorine. One has a relative mass of 35 ( ${}^{35}\text{Cl}$ ) and the other 37 ( ${}^{37}\text{Cl}$ ).

$$\text{Ratio of } {}^{35}\text{Cl} : {}^{37}\text{Cl} = 3:1$$

1. **Multiply** mass of **each isotope** by its **relative abundance**.
2. **Add** these together.
3. **Divide** by the **sum** of the **relative abundances**.

$$\begin{aligned}
 A_r &= \frac{(35 \times 3) + (37 \times 1)}{3 + 1} \\
 &= 35.5
 \end{aligned}$$

## Relative molecular (*formula*) mass ( $M_r$ )

Relative formula mass is the total mass of a compound. To calculate this, we add all the individual  $A_r$  of the atoms that make up the compound.

e.g. Calculate the relative molecular mass ( $M_r$ ) of  $\text{Fe}_2\text{O}_3$ .

$$A_r \text{ of Fe} = 56 \quad \text{Number of Fe atoms} = 2 \quad (2 \times 56) = 112$$

$$A_r \text{ of O} = 16 \quad \text{Number of O atoms} = 3 \quad (3 \times 16) = 48$$

$$\text{Total} = 160$$

### Percentage (%) composition of compounds

After calculating the  $M_r$  it's possible to work out the percentage of an element in a compound using the formula:

$$\% \text{ Percentage mass} = \frac{A_r \times \text{No. of atoms (of that element)}}{M_r \text{ (of the whole compound)}} \times 100$$

The best way to demonstrate this is by example:

Calculate the percentage mass of magnesium in magnesium carbonate,  $\text{MgCO}_3$ .

$A_r$  of Mg = 24

$A_r$  of C = 12

$A_r$  of O = 16

$M_r$  of  $\text{MgCO}_3$  =

$24 + 12 + (3 \times 16)$

= **84**

Now:

$$\% \text{ mass} = \frac{A_r \times N}{M_r} \times 100 = \frac{24 \times 1}{84} \times 100 = \underline{\underline{28.6\%}}$$

This tells us that 28.6% (by mass) of  $\text{MgCO}_3$  is magnesium.

### Chemical Equations

Atoms **aren't made or lost** during a **chemical reaction** – just **re-arranged**.

The reactions can be shown using **word**, **symbol** or **diagram** equations.

e.g.

**Word:** Magnesium + Oxygen → Magnesium Oxide

**Balanced Symbol:**  $2\text{Mg} + \text{O}_2 \rightarrow 2\text{MgO}$

**Diagram:**

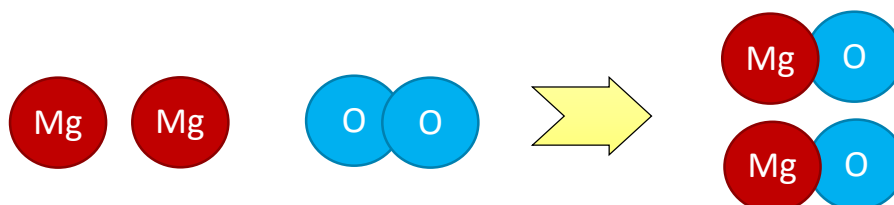

There must always be the **same number of atoms** on **both sides** of the **equation** – so that they are **equal**.

**Left-hand side (LHS):**

Mg = 2      O = 2

**Right-hand side (RHS):**

Mg = 2      O = 2

## Balancing equations

We balance equations by putting numbers **in front** of the formulas when needed.

e.g.

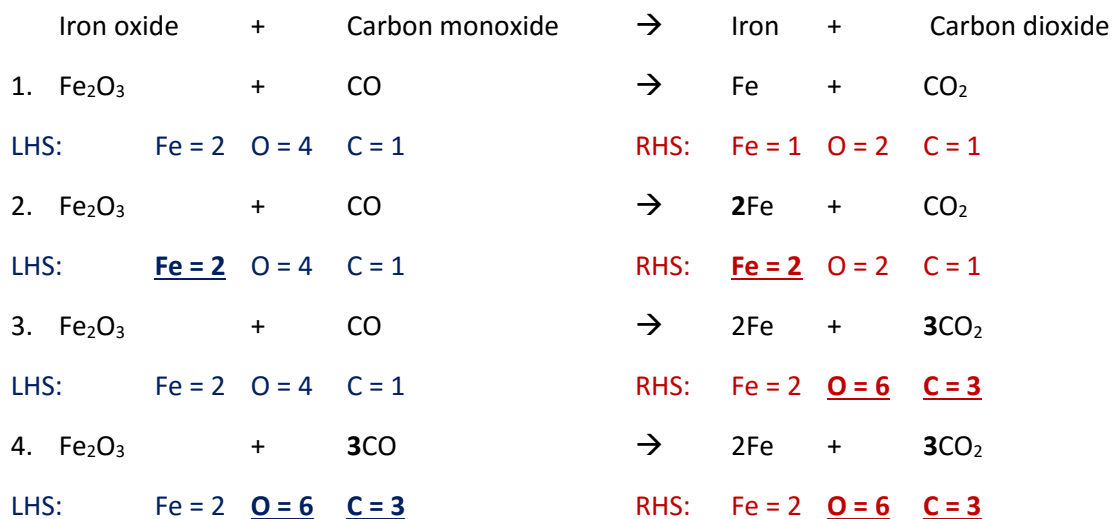
**Blast furnace reaction:**

The number of atoms now balance!

## Balanced mass

We can see above that the **number of atoms** that **go into a reaction** is **equal** to the **number of atoms** that **come out** of a reaction.

This is true for **the mass** also.

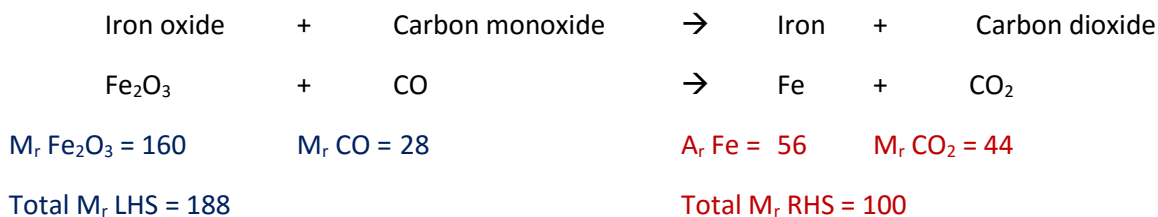
**Blast furnace reaction:**

We can see here that the mass going in **does not equal** the mass coming out.

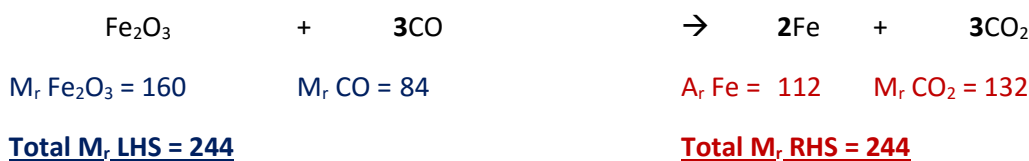

The mass now balances!

## Moles

## Higher Tier

The mole is a term that **describes a specific number** – like the word ‘dozen’ represents the number 12. The mole however is a much larger number  $6.02 \times 10^{23}$  atoms. (6 followed by 23 zeros).

This number is also called **Avogadro constant** or **Avogadro’s number**.

A mole is defined as the number of atoms in exactly 12 grams of Carbon-12 ( $^{12}\text{C}$ ). 12 is the mass number of carbon, so one mole of carbon atoms has a mass of 12 grams.

So... the  $A_r$  or  $M_r$  of a substance **in grams** is known as **one mole of that substance**.

e.g.

Iron has an  $A_r$  of 56.

So, one mole of iron has a mass of 56g.

Nitrogen gas has an  $M_r$  of 28 ( $2 \times 14$ ).

So, one mole of nitrogen gas has a mass of 28g.

Calcium carbonate ( $\text{CaCO}_3$ ) has an  $M_r$  of 100.

So, one mole of  $\text{CaCO}_3$  has a mass of 100g.

$$(40 + 12 + (16 \times 3)) = 100$$

To calculate the number of moles, we use this equation:

$$\text{Number of moles} = \frac{\text{Mass in g (of element or compound)}}{M_r(\text{of element or compound})}$$

**Example 1:**

How many moles of atoms are there in 4.8 g of carbon?

$$\text{moles} = \frac{\text{mass}}{A_r} = \frac{4.8\text{g}}{12} = 0.4 \text{ moles}$$

$A_r \text{ C} = 12$

**Example 2:**

How many moles are there in 640 g of oxygen ( $\text{O}_2$ )?

$$\text{moles} = \frac{\text{mass}}{M_r} = \frac{640\text{g}}{32} = 20 \text{ moles}$$

$A_r \text{ O} = 16$

$M_r \text{ O}_2 = 16 \times 2 = 32$

*Converting moles into mass*

You can **rearrange the equation** to form:  $\text{mass} = \text{moles} \times M_r$

**Example 3:**

What is the mass of 0.6 moles of chlorine molecules ( $\text{Cl}_2$ )?

$$\text{mass} = \text{moles} \times M_r = 0.6 \times 71 = 42.6\text{g}$$

$A_r \text{ Cl} = 35.5$      $M_r \text{ Cl}_2 = 35.5 \times 2 = 71$

**Example 4:**

What is the mass of 0.1 moles of calcium carbonate ( $\text{CaCO}_3$ )?

$$\text{mass} = \text{moles} \times M_r = 0.1 \times 100 = 10.0\text{g}$$

*Calculating the  $M_r$  from moles and mass*

You can **rearrange the equation** to form:

$$M_r = \frac{\text{mass}}{\text{moles}}$$

**Example 5:**

0.5 moles of a compound weighs 80g, calculate its  $M_r$ .

$$M_r = \frac{\text{mass}}{\text{moles}} = \frac{80}{0.5} = 160$$

## Calculations

Calculating the percentage yield (%) of a chemical reaction

The amount of product we get from a chemical reaction is called the **yield**. The more reactants we put in, the higher the **actual yield** will be.

The **percentage yield (%)** tells us the overall success of the experiment. It compares the **predicted yield** (what we should get) with the **actual yield** (what we actually get in practice).

$$\text{Percentage yield (\%)} = \frac{\text{actual yield (in g)}}{\text{predicted yield (in g)}} \times 100$$

e.g. In a manufacturing process 12 tonnes of product are predicted but only 10 tonnes are obtained. What is the percentage yield?

$$\text{Percentage yield (\%)} = \frac{10}{12} \times 100 = 83.33 \%$$

Calculating the masses of reactants or products from a balanced chemical equation

### Higher Tier

By using relative atomic masses ( $A_r$ ) and relative molecular masses ( $M_r$ ) it is possible to **calculate how much of a product is produced** or how much reactants are needed.

#### Product calculation

What **MASS OF MAGNESIUM OXIDE** is produced when 60g of magnesium is burned in air?

<b>Symbol Equation:</b>	$2Mg + O_2 \rightarrow 2MgO$	
<b><math>M_r</math>:</b>	2x24	2 (24+16)
	48	80
<b>Therefore</b>	<b>48g (or tonnes) will produce 80g</b>	
So for every 1g...	1g	$80 \div 48 = 1.67g$
So...	60g will produce $60 \times 1.67 = \underline{100.2g}$	

**Product**  
**Reactant**

#### Reactant calculation (*working backwards*)

What is the **MASS OF MAGNESIUM** needed to produce 90g of magnesium oxide?

<b>Symbol Equation:</b>	$2Mg + O_2 \rightarrow 2MgO$	
<b><math>M_r</math>:</b>	2x24	2 (24+16)
	48	80
<b>Therefore</b>	<b>48g (or tonnes) will produce 80g</b>	
So for every 1g...	1g	$48 \div 80 = 0.6g$
So...	90g will produce $90 \times 0.6 = \underline{54g}$	

**Reactant**  
**Product**

Calculating the formula of a compound from reacting mass data (*Empirical Formula*)**Higher Tier****Example 1**When **4 g of copper oxide** is reduced in a **steam of hydrogen**, **3.2 g of copper** remains.

Work out how much oxygen was contained in the copper oxide.

**1. First step***Find the mass difference*

$$4 - 3.2 = \mathbf{0.8\text{ g}}$$

So for every copper oxide:

	<u>Cu</u>	<u>O</u>
Mass	3.2	0.8
<b>2. Divide with A<sub>r</sub></b>	÷ 64 (A <sub>r</sub> Cu) <b>= 0.05</b>	÷ 16 (A <sub>r</sub> O) <b>= 0.05</b>
<b>3. Divide with smallest</b>	÷ 0.05 <b>= 1</b>	÷ 0.05 <b>= 1</b>

So ratio is

**1 Cu : 1 O****For every 1 Cu there is 1 O****→****Formula = CuO****Example 2**

Find the formula of iron oxide produced when 44.8g of iron reacts with 19.2g of oxygen.

So, for every iron oxide:

	<u>Fe</u>	<u>O</u>
Mass	44.8	19.2
Divide with A <sub>r</sub>	÷ 56 (A <sub>r</sub> Fe) <b>= 0.8</b>	÷ 16 (A <sub>r</sub> O) <b>= 1.2</b>
Divide with the smallest value	0.8 ÷ 0.8 <b>= 1</b>	1.2 ÷ 0.8 <b>= 1.5</b>

A formula must have **whole numbers** therefore the ratio is:**2 Fe : 3 O****For every 2 Fe there are 3 O****→****Formula = Fe<sub>2</sub>O<sub>3</sub>**

## Mixtures

A mixture is made from different substances that are **not chemically joined**.

For example, powdered iron and powdered sulphur mixed together makes a mixture of iron and sulphur. They can be **separated** from each other **without a chemical reaction**, in the way that different coloured sweets can be picked out from a mixed packet and put into separate piles.



Element	Compound	Mixture of elements	Mixture of elements and compounds

Atoms/molecules in mixtures can be easily separated by physical processes such as:

1. Filtration
2. Evaporation
3. Chromatography
4. Distillation

### Filtration

#### INSOLUBLE SOLID FROM LIQUID

Filtration is good for separating an **insoluble solid** from a **liquid**. (An insoluble substance is one that **does not dissolve**).

Sand, for example, can be separated from a mixture of sand and water using filtration. That's because sand does not dissolve in water.

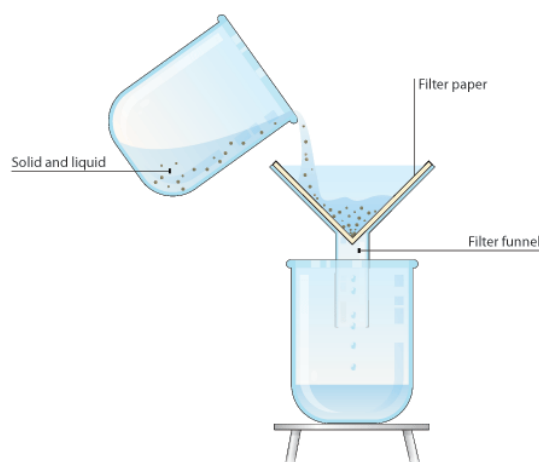

## Evaporation

### SOLUBLE SOLID FROM LIQUID

This is good for separating a **soluble solid** from a **liquid** (a soluble substance **does dissolve**, to form a **solution**).

For example copper sulfate crystals can be separated from copper sulfate solution using evaporation. Remember that it is the **water that evaporates away**, not the solution.

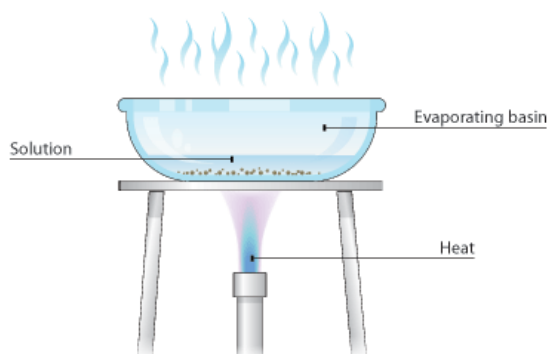

## Chromatography

### SEPARATING LIQUIDS DUE TO MASS

Chromatography can be used to **separate mixtures of coloured compounds**. Mixtures that are suitable for separation by chromatography include *inks, dyes and colouring agents in food*.

**Simple chromatography** is carried out on **paper**.

A spot of the mixture is placed near the bottom of a piece of chromatography paper and the paper is then placed upright in a suitable solvent, e.g. water. As the solvent soaks up the paper, it carries the mixtures with it. Different components of the mixture will move at different rates. This separates the mixture out.

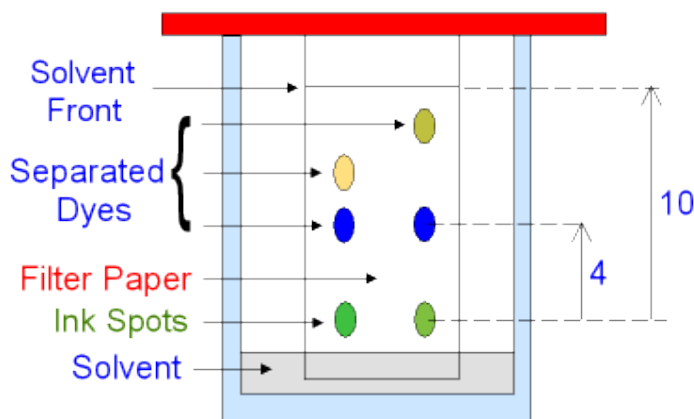

### *R<sub>f</sub>* values

Different chromatograms and the separated components of the mixtures can be identified by calculating the *R<sub>f</sub>* value using the equation:

$$R_f = \frac{\text{distance moved by the compound}}{\text{distance moved by the solvent}}$$

The *R<sub>f</sub>* value of a particular compound is always the same - if the chromatography has been carried out in the same way. This allows industry to use chromatography to identify compounds in mixtures.

e.g. In the above diagram, the blue dot has risen 4 cm and the solvent has risen 10cm. Therefore, the *R<sub>f</sub>* value of the blue dot is:

$$R_f = \frac{\text{distance moved by the compound}}{\text{distance moved by the solvent}} = \frac{4}{10} = \mathbf{0.4}$$

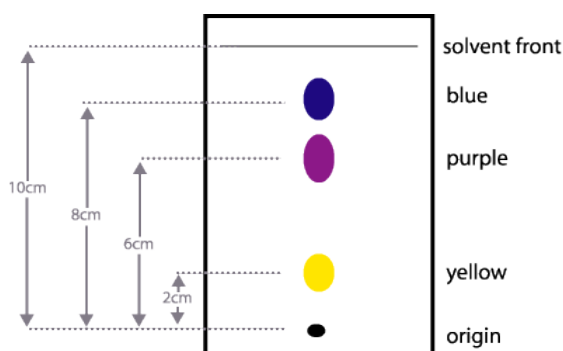

*Try working out the *R<sub>f</sub>* values of the blue, purple and yellow compounds on the left.*

## Distillation

### SEPARATING LIQUIDS DUE TO BOILING POINT

*Distillation – Separating water and miscible liquids.*

Pure liquids have specific boiling points, e.g. water boils at 100°C. Ethanol boils at 78°C. Water and ethanol are **miscible** (when two liquids mix together easily without separating into layers).

This method works because the liquids in the mixture have **different boiling points**. When the mixture is heated, one liquid evaporates before the other.

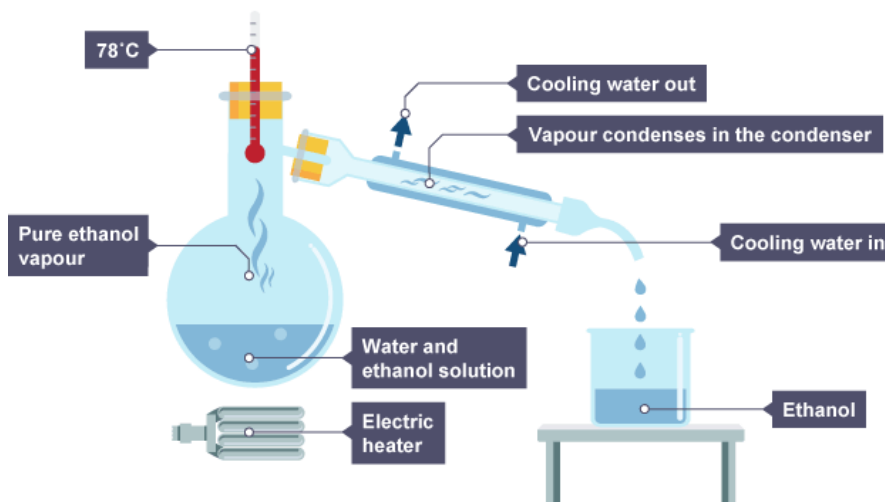

## Chemical reactions

How do we know if a chemical reaction has taken place?

You may not be able to see that any new substances have formed during a change. Below are some signs that a chemical change may have occurred.

### Change in Temperature

Chemical changes often are accompanied by a **change in temperature**. You may have noticed that the temperature is higher near logs burning in a campfire.

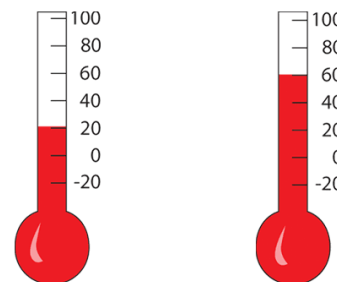

**Exothermic** – Heat is given **out** (think **exit**).

**Endothermic** – Heat is **absorbed**.

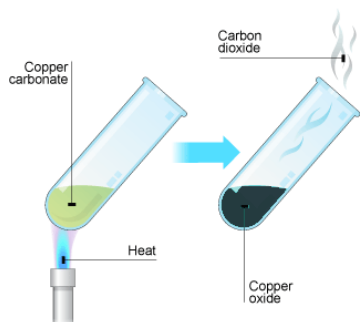

### Change in Colour

A change in **colour** is often an indication of a chemical change.

Think of iron rusting....

### Formation of a Gas (Effervescence)

The formation of **gas** or bubbles is another indicator that a chemical change may have occurred.

In the reaction on the left, CO<sub>2</sub> is given off.

### Formation of a Solid

When **two liquids are combined**, a **solid** called a **precipitate** can form. The shells of animals such as clams and mussels are precipitates. They are the result of a chemical change involving substances in seawater combining with substances from the creatures.

## Topic 2 - Atomic structure & the Periodic Table

### Atoms – recap

See Topic 1 for more information

Atoms have **no charge**. (Overall = **Neutral**)

The number of protons (in the nucleus) is always the same as the number of electrons (in shells)

- Protons are **positively** charged. (+)
- Electrons are **negatively** charged (-)
- **Neutrons** do not have a charge (0) – they are **neutral**

PARTICLE	RELATIVE MASS	CHARGE
<b>Proton</b> - Nucleus	<b>1</b>	<b>+1</b>
<b>Neutron</b> - Nucleus	<b>1</b>	<b>0</b>
<b>Electron</b> - Orbit	<b>0.0005</b>	<b>-1</b>

Lithium Atom

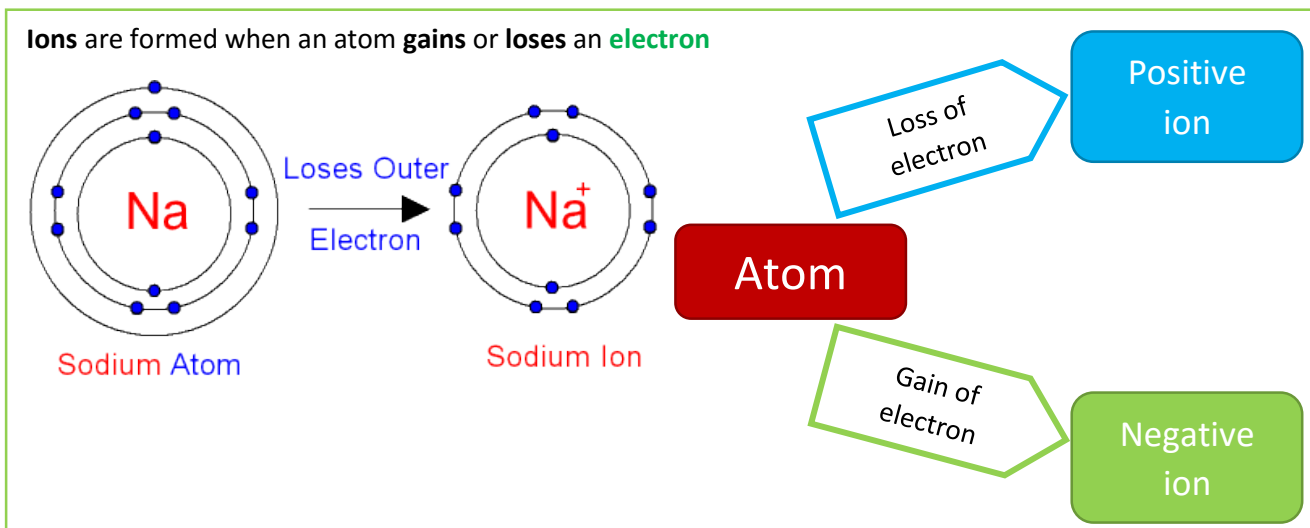
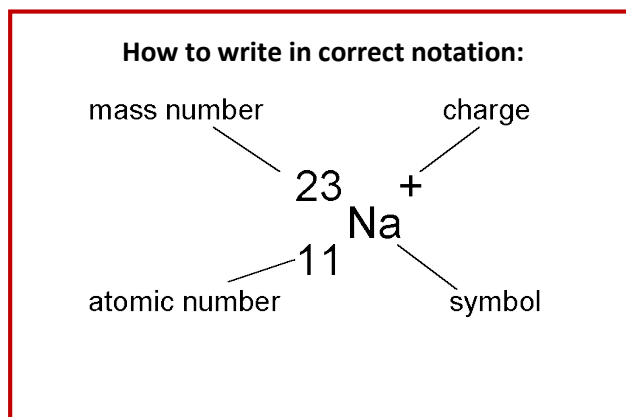
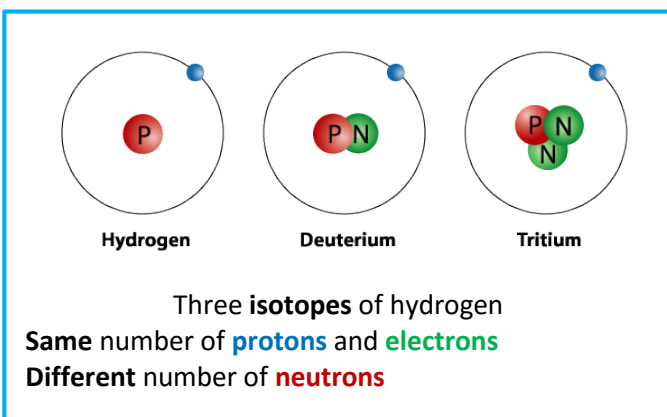
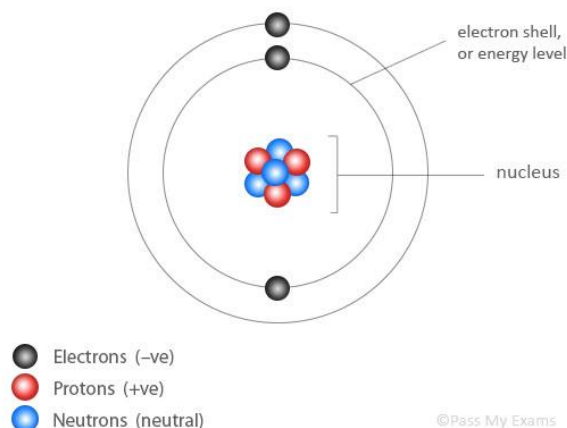

### The Periodic Table

All the **different elements** are arranged in a chart called the periodic table. A Russian scientist called **Dmitri Mendeleev** produced one of the first practical periodic tables in the 19th century. The modern periodic table is based closely on the ideas he used:

- the elements are arranged in **order of increasing atomic number**
- the **horizontal** rows are called **periods**
- the **vertical** columns are called **groups**
- elements in the same group have similar properties to each other
- **metals** appear on the left side of the table, **non-metals** on the right

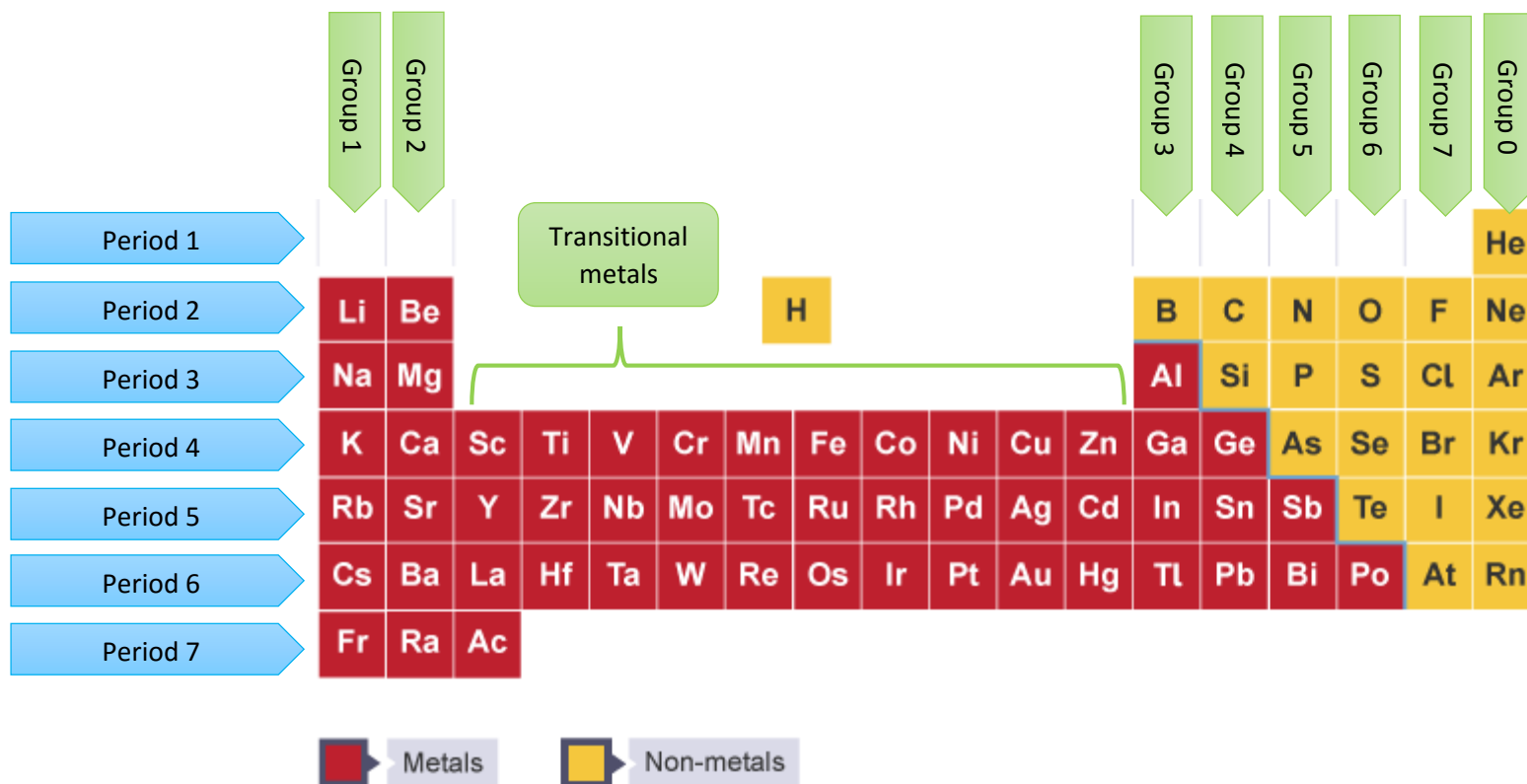

Elements that appear close to the divide between the metals and non-metals often have **intermediate properties**.  
That is that they can sometimes behave like metals and/or non-metals.

## Metals

Iron, magnesium and gold are examples of metal elements. Metals have properties in common. They are:

- **shiny**, especially when they are freshly cut
- **good conductors** of heat and electricity
- **malleable** (they can be bent and shaped without breaking)

Most metals also have other properties in common. They are:

- **solid** at room temperature, except mercury
- **hard** and **strong**
- they have a **high density**
- they are **sonorous**



Gold



Copper

Three metals (iron, cobalt and nickel) are **magnetic**. Steel is a mixture of elements but it is mostly iron, so it is also magnetic. The other metal elements are not magnetic.

## Non-metals

Oxygen, carbon, sulfur and chlorine are examples of non-metal elements. Non-metals have properties in common. They are:

- **dull** (not shiny)
- **poor conductors** of heat and electricity (they are insulators)
- **weak** and **brittle** (they easily break or shatter when solid)

Most non-metals also have these properties:

- they have a **low density** (they feel light for their size)
- They are NOT sonorous (they do not make a ringing sound when hit)



Eleven non-metals are **gases** at room temperature, including oxygen and chlorine. One non-metal, bromine, is a **liquid** at room temperature. The other non-metals are **solids** at room temperature, including carbon and sulfur.

## Electronic Structure

The electrons in an atom occupy **energy levels**. These are also called **shells** or **orbits**. Each electron in an atom is found in a particular energy level. The lowest energy level (innermost shells) fill with electrons first. Each energy level can **only hold a certain number** of electrons before it becomes full. The first energy level can hold a maximum of two electrons, the second energy level a maximum of eight, and so on.

Electrons in the first three energy levels for the elements with atomic numbers 1 to 20:

Energy level or shell	Maximum number of electrons
First	2
Second	8
Third	8

**You need to be able to write the electronic structure of any of the first twenty elements.**

### Writing an electronic structure

The electronic structure of an atom is written using numbers to represent the electrons in each energy level. For example, for **sodium this is 2,8,1** – showing that there are:

- 2 electrons in the first energy level
- 8 electrons in the second energy level
- 1 electron in the third energy level.

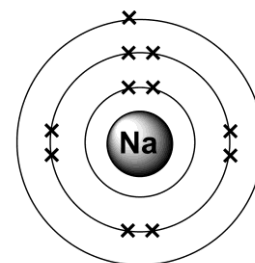

You can work out the electronic structure of an atom from its atomic number or its **position in the periodic table**. Start at hydrogen, H, and count the elements needed to reach the element you are interested in. For sodium, it takes:

- 2 elements to reach the end of the first period (row)
- 8 elements to reach the end of the second period
- 1 element to reach sodium in the third period.

The diagram of the periodic table shows how this works.

	Group								
	1	2	3	4	5	6	7	0	Number of occupied energy levels
Period 1								2 He 2	1
Period 2	3 Li 2.1	4 Be 2.2	5 B 2.3	6 C 2.4	7 N 2.5	8 O 2.6	9 F 2.7	10 Ne 2.8	2
Period 3	11 Na 2.8.1	12 Mg 2.8.2	13 Al 2.8.3	14 Si 2.8.4	15 P 2.8.5	16 S 2.8.6	17 Cl 2.8.7	18 Ar 2.8.8	3
Period 4	19 K 2.8.8.1	20 Ca 2.8.8.2							4
	1	2	3	4	5	6	7	8	

Number of electrons in highest occupied energy level (except for helium)

## Group 1 – The Alkali Metals

### Physical and chemical properties

#### Physical properties

- All metals look **dull on the outside**
- Over a short period, a **layer of oxide** makes the metal look dull
- The **inside** of every metal is **shiny**
- It is possible to **cut** every metal with a **knife**
- They are kept in **oil** to prevent them from **reacting with oxygen** and **moisture in the air**.
- Their **density** is **low** therefore most **float**
- The **boiling point** and **melting point** are **lower** than many other metals

All group 1 metals have **1 electron** in the outer shell. This makes them **very reactive**, as they bond by losing an electron.

Reactivity increases down the group as the 1 outer electron is **more easily lost**, because it's **further** from the **nucleus**.

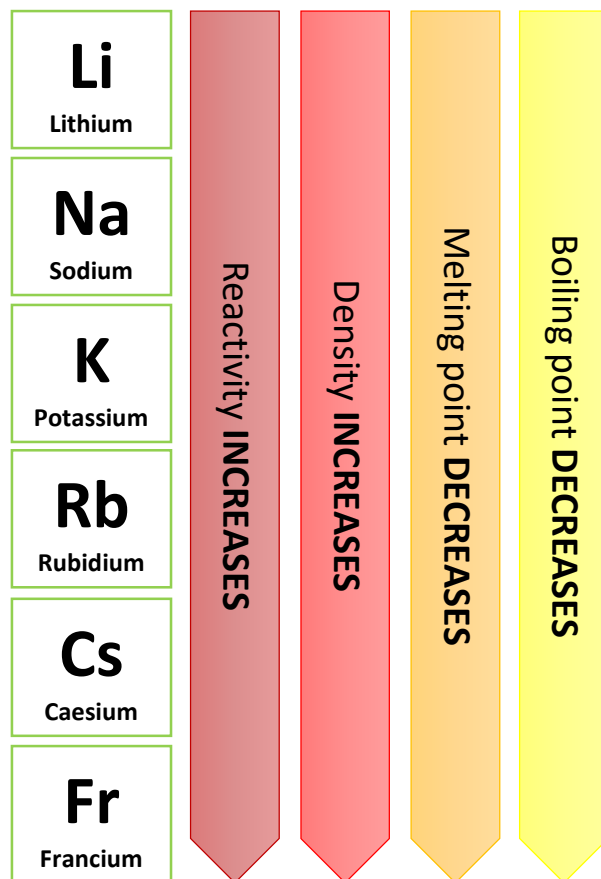

### Chemical properties

*React with oxygen to form oxides*



e.g. potassium

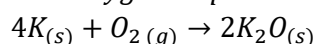
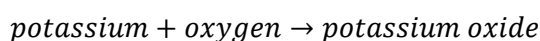

The **oxide layer**, that makes the metal look dull, forms **quicker** as we go **down the group**.

*React with water to form hydroxides (alkalis)*



e.g. lithium

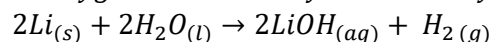
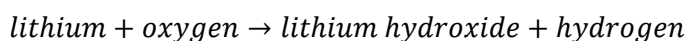

- The metals create **alkali** as it reacts water (**purple** with universal indicator)
- The reaction of the metal with water creates **hydrogen**
- The metal **floats, moves** and **fizzes**.
- **Sodium** - In addition moves **quicker** and has a **ball shape**.
- **Potassium** - In addition it moves **quickly** and has a **lilac flame**.

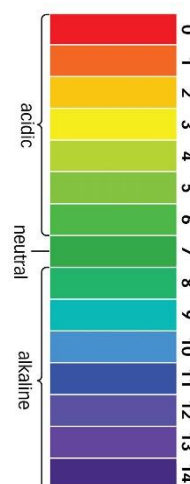

## Group 7 – The Halogens

Physical and chemical properties

### Physical properties

- **Chlorine** – Yellow-green gas
- **Bromine** – Orange-red liquid – orange vapour
- **Iodine** - Shiny grey solid – purple vapour
- The halogens become **less reactive** down the group
- Poisonous vapours

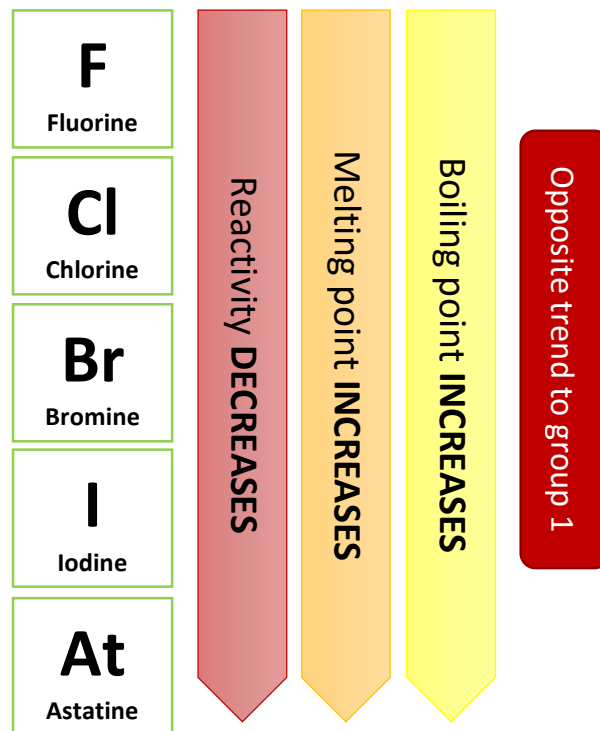
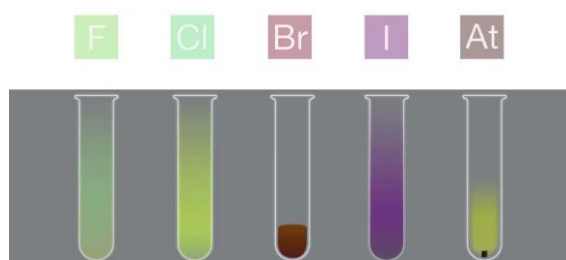

All group 7 elements have **7 electrons** in the outer shell. This makes them **very reactive**, as they bond by gaining an electron, to form a very stable full outer shell.

Reactivity decreases down the group as the 7 outer electrons are further away from the nucleus. Due to less attraction, it is harder to gain an electron.

### Chemical properties

#### Reactions of *halogens* with *alkali metals*

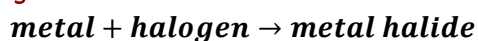

e.g. potassium and chlorine

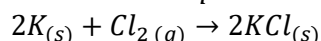
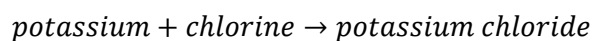

All **metal halides (salts)** formed are **white solids**.



wiseGEEK

#### Reactions of *halogens* with *iron*

Halogens and their reaction with iron wool

- **Fluorine** - **Reacts** with almost anything **instantly**. Very few scientists handle fluorine because it is so **dangerous**.
- **Chlorine** - **Reacts** with heated iron wool **very quickly**.
- **Bromine** – Must be **warmed** and the iron wool heated. The reaction is faster.
- **Iodine** - Must be **heated strongly** and so does the iron wool. The reaction is **slow**.

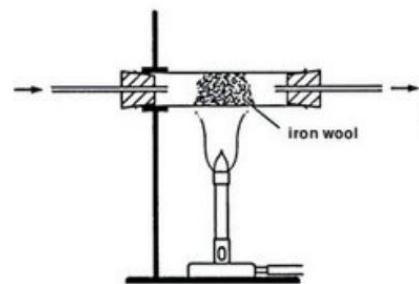

## The properties and uses of halogens and halides

The halogens have uses both as elements and compounds.

### Chlorine

1. Chlorine is a **disinfectant** - it kills bacteria (*see iodine below*). It is used to kill bacteria in drinking water and swimming pools.
2. Chlorine dissolved in sodium hydroxide solution is **bleach**. It forms sodium chlorate(I) - NaOCl. Domestic bleach contains about 5% NaOCl<sub>(aq)</sub>.
3. Chlorine dissolved in water forms:  
chloric(I) acid (HOCl<sub>(aq)</sub>) + hydrochloric acid (HCl<sub>(aq)</sub>)  
Chloric(I) acid is also bleach.
4. Chlorine is used in the **manufacture** of many chemicals including **insecticides**, **CFCs** and the polymer **PVC**.



### Iodine

1. Iodine can also be used as an **antiseptic** to kill bacteria. There is a difference between an **antiseptic** and a **disinfectant**.  
They both kill germs but a disinfectant is **stronger** than an antiseptic.  
An antiseptic is safe to use on the skin to help prevent infection but a disinfectant will damage skin cells.
2. Iodine dissolved in alcohol (ethanol) was commonly used as an **antiseptic** in the past. It was called "Tincture of iodine".
3. Iodine plays an **important role** in the **body** (*see potassium iodide below*).



### Fluorides

Fluorides are added to **toothpaste** and in some places added to **drinking water**. It has been shown that **fluorides** can reduce **dental decay** (damage to teeth) especially in young children.

### Bromides and Iodides

Silver bromide and silver iodide are **sensitive to light** and are used in **photographic film**. Silver bromide is almost white, and when light falls on it, it splits up into silver metal and bromine.

The silver metal appears as a black mark on the film, producing a black and white (monochrome) negative.



### Potassium Iodide

Potassium iodide (KI) is added to sodium chloride (common salt - see below) to **prevent a lack of iodine** in the **diet**.

### Sodium Chloride

Sodium chloride (NaCl) is **common salt**.

1. Salt is used in the **food industry** as a **flavouring** and as a **preservative**.
2. Salt is also mixed with grit and spread on roads to **prevent roads freezing** in cold conditions.
3. Sodium chloride solution is used in a **water softener** to regenerate the ion exchange column.
4. **Electrolysis** of sodium chloride solution is used to make **chlorine** gas, **hydrogen** gas and **sodium hydroxide**.



## Displacement reactions

### Higher Tier

More reactive halogens will **displace** less reactive ones.

If a reactive element comes into contact with the compound of a less reactive element a chemical reaction may take place. The **less reactive element is removed** from the compound and **replaced** by the **more reactive element**.

For example, if **chlorine** is added to a solution of **sodium bromide**, the **bromine** is replaced by the **chlorine** forming **sodium chloride**. Bromine is formed at the same time and can be detected by its colour.

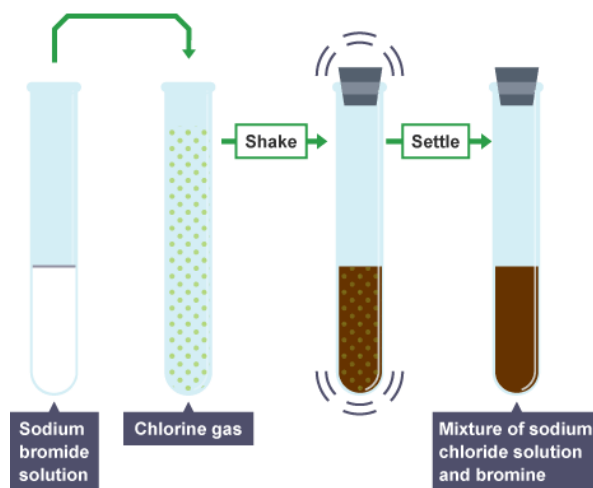

Examples of displacement reactions:

1. **chlorine** + sodium bromide → sodium **chloride** + bromine  
*chlorine **more reactive** than bromine*
2. **chlorine** + sodium iodide → sodium **chloride** + iodine  
*chlorine **more reactive** than iodine*
3. bromine + sodium chloride → **no reaction**  
*bromine **less reactive** than chlorine*
4. **bromine** + sodium iodide → sodium **bromide** + iodine  
*bromine **more reactive** than iodine*
5. iodine + sodium chloride → **no reaction**  
*iodine **less reactive** than chlorine*
6. iodine + sodium bromide → **no reaction**  
*iodine **less reactive** than bromine*

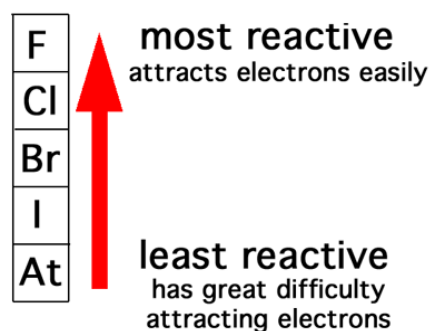

## Identifying hydrogen gas

### Test for hydrogen gas

A splint is lit and held near the opening of the tube, then the stopper is removed to expose the splint to the gas. If the gas is **flammable**, the mixture ignites. This test is most commonly used to identify hydrogen, which ignites with a distinctive '**squeaky pop**' sound.



## Identifying Ions

### Flame test - cations

Flame tests are used to identify the presence of some **metal ions** in a compound.

**Lithium**  $\text{Li}^+$  - red

**Sodium**  $\text{Na}^+$  - orange

**Potassium**  $\text{K}^+$  - lilac (pink)

**Calcium**  $\text{Ca}^{2+}$  - orange-red

**Barium**  $\text{Ba}^{2+}$  - pale green



### Procedure:

1. Dip a clean flame test loop in the sample solution
2. Hold the flame test loop at the edge of a Bunsen burner flame
3. Observe the changed colour of the flame, and decide which metal it indicates
4. Clean the loop in acid and rinse with water, then repeat steps 1 to 3 with a new sample



### Silver nitrate solution - halides

You can test to see if a solution contains **chloride**, **bromide** or **iodide** ions by using **silver nitrate**. If silver nitrate solution is added to a sample of water containing halide ions the **silver halide** is **precipitated**. This is because the silver halides are all **insoluble** in water.

The results look like this:

- Silver **chloride** is a **white** precipitate  
 $\text{Ag}^+_{(aq)} + \text{Cl}^-_{(aq)} \rightarrow \text{AgCl}_{(s)}$
- Silver **bromide** is a **cream** precipitate  
 $\text{Ag}^+_{(aq)} + \text{Br}^-_{(aq)} \rightarrow \text{AgBr}_{(s)}$
- Silver **iodide** is a **pale-yellow** precipitate  
 $\text{Ag}^+_{(aq)} + \text{I}^-_{(aq)} \rightarrow \text{AgI}_{(s)}$

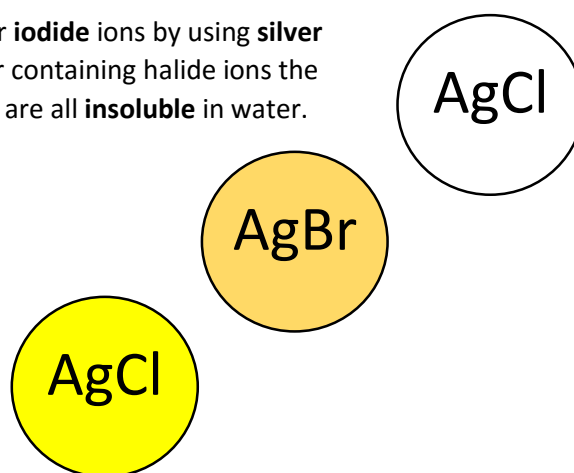

## Group 0 – The Noble Gases

These are all colourless **monatomic gases**. Monatomic means that the gases exist as single, un-bonded atoms. Their **melting points** and **density** rise as we go down the group.

### *Uses of the noble gases*

Here are some of the main uses of the noble gases:

**Helium** is used:

- in balloons
- in the mixture of gases deep-sea divers breathe
- in its liquid state, to cool the superconducting magnets in body scanners



**Neon** is used:

- in electric discharge tubes (used in advertising signs)

**Argon** is used:

- inside light bulbs
- in welding, to stop the hot metal oxidizing

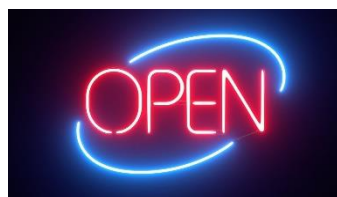

**Krypton** is used:

- in lasers used to operate on eyes

**Radon** is used:

- to treat cancers (its radioactive atoms destroy cells)

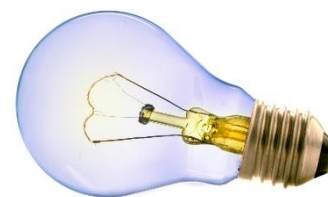

### *Why are the noble gases so unreactive?*

The **noble gases** were originally called the inert gases. The word '**inert**' describes a substance that has **no reactions**. However, in 1962 the first compound containing a noble gas was made and the group was later renamed!

Look at the electronic structures of the noble gases:

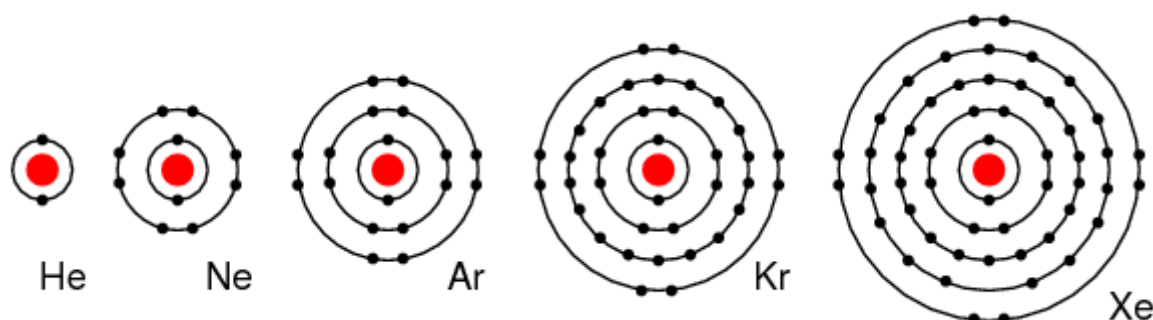

It is the complete highest energy level (**full outer shell**) that makes the atoms of a noble gas so **stable** and **unlikely to react**. There are only a few compounds of noble gases, mainly formed with the reactive elements fluorine and oxygen, and then only with the larger noble gases.

## Topic 3 – Water

### What's in our water?

Water is necessary for **life to exist**. The quality of life depends on the **availability** of **clean water**. Water in this country is made **drinkable** by **treating rainwater**.

Everyone's aware that the **formula** for **water** is **H<sub>2</sub>O**, but the water that we use daily contains more than just hydrogen and oxygen.

Water is a fantastic **solvent**; it dissolves two main types of **solutes**:

- **Ions** – As water flows over the ground, it picks up various ions from minerals. e.g. **Mg<sup>2+</sup>**, **Ca<sup>2+</sup>**, **Na<sup>+</sup>** and **K<sup>+</sup>**
- **Gases** – As water falls as rain, **oxygen** (essential for marine life) and **carbon dioxide** (essential for plant life, reduces pH of the water) **dissolve** in the water.

Other things that water picks up on its travels contain **microorganisms**, which are **natural pollutants** and include **bacteria** and **viruses**, and **man-made pollutants** including **fertilisers**, **pesticides** and **household** and **industrial waste**.

### Sustainable water supply

Although there is ample water on Earth, only a **very small fraction** is **safe** for **drinking**. With an **increasing population** and **developing industry** our need for water is larger than ever.



#### Why do we need water?

- Water is needed in factories for cooling machinery
- Hygiene – We need water to keep clean and wash clothes
- We need drinking water
- Water is needed on farms to grow food

We use **150 litres** of water each on **average** every day. The water comes from **natural underwater storage**, rivers and **different reservoirs**. During **dry conditions** when there is **not enough rain** there is a strain on the water supply – areas will experience **drought**.

**Shortage** of water problems arise when there is **more demand than supply** of water, which is a threat to **life** and the **environment**. Water cost may increase if future climate changes cause shortage of water in the UK. Using less water in the future is very important. Here are some ways of decreasing our use of water.

- Use washing machines and dish washers only when they are full
- Having a shower instead of a bath
- Use waste water for plants and to wash the car
- Repair dripping taps
- Do not allow the water to run excessively (e.g. when brushing teeth)

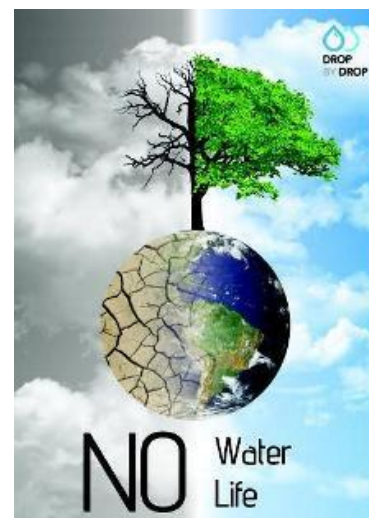

## Treatment of public water

We need to know the process in which water is made safe for consumption:

1. **Water in** – groundwater and rivers provide water to reservoir
2. **Coarse filter** – removes larger particles
3. **Sedimentation** – in reservoirs/tanks, larger solid particles settle under gravity.
4. **Fine filtration** – through layers of sand and gravel, removes smaller insoluble particles.
5. **Chlorination** – chlorine added to kill bacteria, prevents disease/makes it safe to drink.

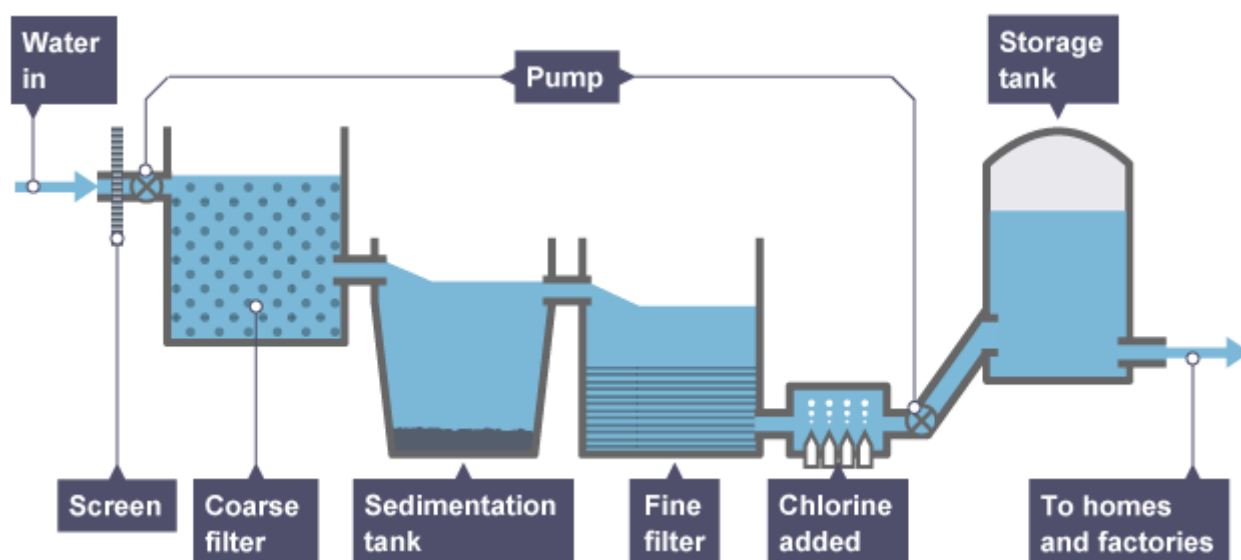

## Desalination of sea water

The simplest method for **desalination** of sea water is **distillation**. This involves **boiling sea water** which uses **large amounts** of costly **energy**, preventing it from being a viable process in many parts of the world.

You need to be aware that other methods are also used, e.g. the use of **membrane systems**.

If a country is to use desalination they need to ensure:

- a **renewable** means of creating **heat** energy where no **carbon dioxide** is created (greenhouse effect)
- **sea nearby**



You should also be able to discuss the potential of desalination as a **source of drinking water** in different parts of the world in terms of **proximity** to the **sea**, availability of '**cheap**' **energy** and a country's wealth.

## Fluoridation

Fluoride is a **naturally occurring** ion found in water in **varying amounts**, depending on **where in the UK** you live.

You need to be able to present the **arguments for and against the process** and you are expected to know that fluoridation of water supplies is a **controversial issue**.

It can help to **prevent tooth decay**, which is why it's added to many brands of **toothpaste** and, in some areas, to the **water supply** through a process called **fluoridation**.

### Community water fluoridation

**Most water supplies contain some fluoride** and in the early 20th century, levels of tooth decay were found to be associated with fluoride levels in drinking water. This led to the introduction of water fluoridation schemes to add fluoride to water supplies to improve **dental health**.

Community water fluoridation schemes have operated for over 70 years; the first fluoridation scheme was introduced in the US in 1945. The first substantive UK scheme was established in Birmingham in 1964.

The decision about whether to add fluoride to the water supply is made by individual local authorities.

### Is fluoride safe?

There have been some **concerns** that fluoride **may be linked** to a variety of **health conditions**.

The link between fluoride ions and a reduction in incidence of tooth decay has been established by **surveying** school children of various ages, and that the **data is reliable** because all school children are surveyed and only absentees on the day are excluded.

Many people object to proposals to fluoridate water supplies for several reasons:

- Fluoride can be harmful in high concentrations, e.g. causing **discolouring or decay of teeth** (fluorosis).
- High fluoride intake has also been linked to **stomach** and **bone cancers** and to **infertility**.
- Some argue against fluoridation because it is '**mass medication**' and that no one should be forced to consume fluoride.



### Ethical issues

It is important for you to realise that science cannot address **ethical issues** and therefore cannot answer the question as to whether it is correct to fluoridate water supplies. **Science** can only provide the **facts** and **evidence** required for people to form their **own opinions**. You should also be aware that information relating to the fluoridation of water supplies comes from **many different sources** and that some of these **may be biased** and may try to **influence opinions**.

## Solubility

Sometimes when you add a **solid** to a **liquid**, the bonds between the solid particles break and the particles **mix** with the liquid – forming a **solution**. This process is called **dissolving**.

Term	Definition
Solution	<b>Mixture of solid (solute) and liquid (solvent)</b> that doesn't separate out e.g. brine
Solute	Solid (or substance) being dissolved e.g. salt
Solvent	The liquid being dissolved into e.g. water
Soluble	Means it <b>will</b> dissolve
Insoluble	It <b>won't</b> dissolve
Solubility	<b>How much</b> of the solute will dissolve in the solvent

Soluble solids dissolve **more readily when heated**. Every solid has a **different** rate of solubility.

You need to be familiar with the following methods:

- Adding a **known mass** of solute (e.g. ammonium chloride) to a **measured volume** of water, which will only dissolve a portion of the solute; if we filter, dry and weigh the **excess solute**, you'll be able to **determine solubility**.

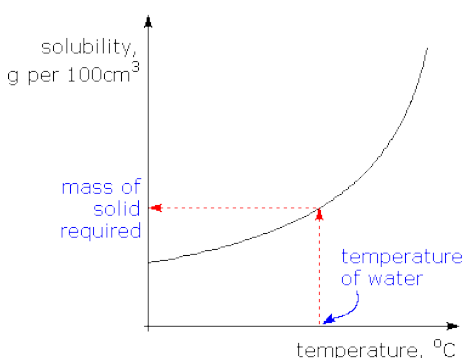

- Adding **slightly** more weighed solute (e.g. potassium chlorate) than will dissolve to a **measured volume** of water at **room temperature**; if we then heat solution until **all solute dissolves** and then allow to **cool** and record temperature at which **crystals first appear**; we'll be able to determine **solubility at each temperature** by repeating several times with increasing volumes of water; from this data, we will then be able to plot a **solubility curve**.

### Solubility curves

Every solid has a **different** rate of solubility.

We can see this from reading and deducing information from a graph.

e.g. Concluding for the potassium nitrate and sodium chloride solubility curves, we see that potassium nitrate is less soluble than sodium chloride to a point, then it's solubility rises greatly, in a non-linear way.

The solubility of potassium nitrate and sodium chloride are exactly the same at one point only (where the two curves cross).

Sodium chloride's solubility increases linearly slightly as the temperature rises.

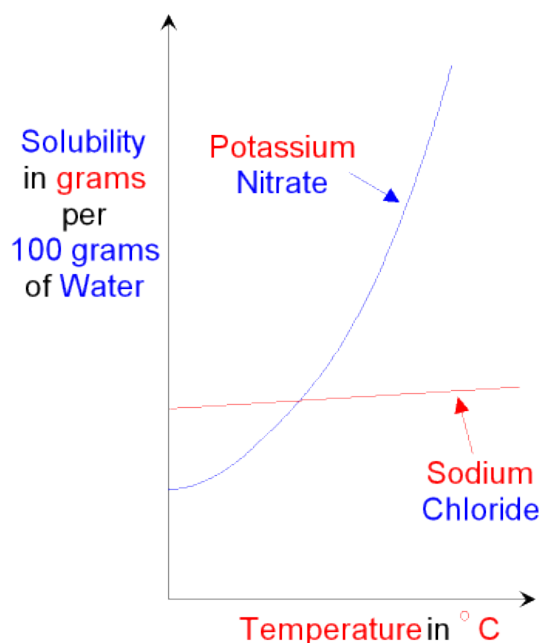

## Hard and soft water

Depending on the type of rocks a region has, water can be of two types - **Hard water** and **Soft water**.

### Hard Water

If rainwater passes along **limestone** (calcium carbonate) rocks on its way to a reservoir, **calcium ions  $\text{Ca}^{2+}$**  will collect in the water. Other ions such as magnesium ions  $\text{Mg}^{2+}$  can also collect in water. **These additional ions make the water hard.**

*Soap in hard water does not readily lather, scum is formed*

**Hardness in water is defined as difficulty in producing a lather with soap.**

There are two types of hard water:

- Temporary hard water
- Permanently hard water

### Temporary hard water

Calcium hydrogen carbonates ( $\text{Ca}(\text{HCO}_3)_2$ ) and magnesium hydrogen carbonates ( $\text{Mg}(\text{HCO}_3)_2$ ) form **temporary** hard water because when this water is boiled, hardness is removed as **hydrogen carbonates** are decomposed.

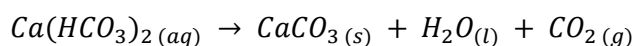

This process forms magnesium carbonate and calcium carbonate which are **insoluble**. This forms **lime scale** and collects on kettles as 'fur'.

### Permanently hard water

When insoluble calcium and/or magnesium **sulfates** exist in water it is called **permanently** hard water.

### Treating permanently hard water

#### 1. Washing soda

Sodium carbonate ( $\text{Na}_2\text{CO}_3$ ), also known as **washing soda**, can soften both temporary and permanent hard water. It is **soluble** in water and adds a large amount of **carbonate** ions to the water. These react with dissolved calcium ions, forming a precipitate of calcium carbonate:

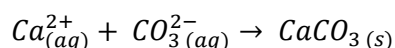

**Remember:** the **calcium ions** come from the **hard** water and the **carbonate** ions from the **washing soda**.

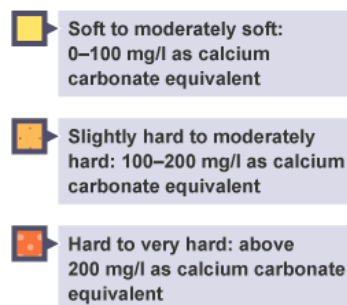
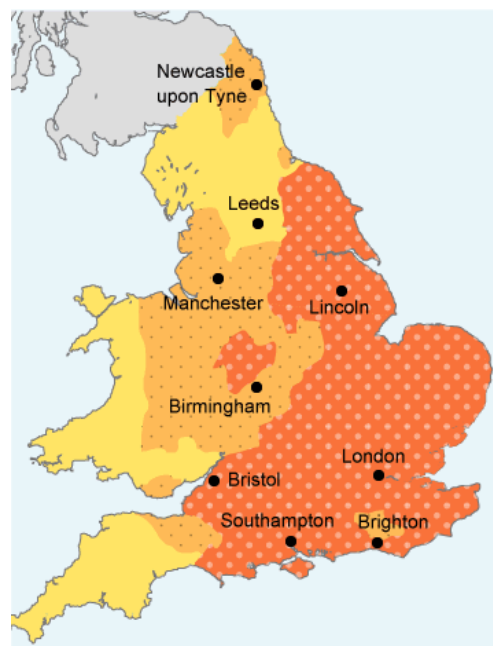

## 2. Ion-exchange

**Ion-exchange resins** can also soften both temporary and permanent hard water. The resin is made into **small balls** around 1–2 mm in diameter, which are packed into a **tube** or ‘**column**’. The ion-exchange resin starts with **sodium** ions stuck to it.

As the hard water **passes** through the column, **sodium** ions **come off the resin** and go into the water, while **calcium** ions come out of the water and **stick to the resin**. In effect, calcium ions that cause hardness are swapped for sodium ions that do not cause hardness.

Dishwashing machines contain ion-exchange resin to soften the water used to wash the dishes. The resin needs recharging with dishwasher salt (**sodium chloride**) once it becomes full of calcium ions.

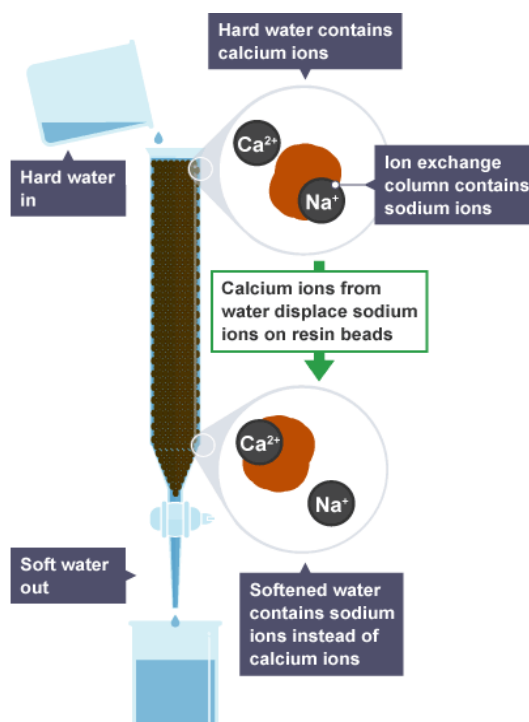

*Experiment to determine if water is soft, permanently hard or temporarily hard*

Soap solution is added every 1 cm<sup>3</sup> to the water and the flask shaken to try and form lather (bubbles). When lather starts to form the soap solution is added every 0.5 cm<sup>3</sup> until it stays permanently.

The amount of soap solution can be determined using a buret. Soft water lathers easily therefore little amount of soap solution is used. Hard water lathers slowly therefore more soap solution is needed.

If two samples of water seem to be hard water, samples of both types of water could be boiled. The same experiment as above could then be undertaken.

If the water is still difficult to lather, then the water is permanently hard.

**The health benefits of hard water and its negative effects**

### Advantages

1. Strengthens teeth
2. Reduces the risk of heart disease
3. Some people prefer the taste of hard water



### Disadvantages

1. Lime scale on kettles make them less efficient at boiling water and therefore waste energy. Hot water pipes can also block up with lime scale
2. Removing scale can be expensive
3. More soap is needed with hard water
4. Ion exchange water softeners release sodium ions which can be unsuitable for some uses
5. Ion exchange units need to be ‘cleaned’ out of magnesium and calcium ions when it has filled up (usually with sodium chloride (salt))

## Topic 4 – The ever-changing Earth

### Structure of the Earth

#### The Inner Core

The **hottest** part of the Earth, temperatures up to 5,500 °C made primarily of **iron** with some nickel.

#### The Outer Core

**Liquid** layer that is also made of iron and nickel, nearly as hot as the inner core.

#### The Mantle

The **thickest** part of the Earth contains **semi-molten rock**, more solid towards the outer edge of the mantle and more molten towards the core.

#### The Crust

The thinnest part of the Earth, it's thickness varies but can be up to 70 km.

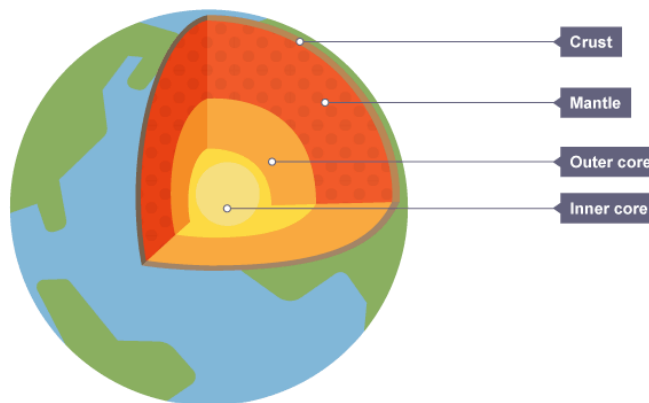

### Plate Tectonics

#### Ever-changing Earth

Over billions of years the Earth has continuously changed. These changes are often **slow**. Two million years ago the Earth's continents were in one block called **Pangaea**.

We now know that the crust and upper part of the mantle are **fragmented** into large pieces called **tectonic plates**. These plates “float” on the mantle. They don't stay in one place; **convection currents** cause the plates to drift. These plates move at speeds of a few cm per year. Occasionally plates can move suddenly which causes earthquakes. Volcanoes and earthquakes often occur between **boundaries** of two plates.

You need to know that the Earth's outer layer, called the **lithosphere** (crust and rigid part of the mantle), is broken into 7-8 major and many minor plates.

#### Alfred Wegener

Observations about the Earth couldn't be explained and in 1914 Alfred Wegener hypothesised that **Africa and South America** had previously been **one continent** which had then split. He looked for evidence to back up his hypothesis.

These were:

- Matching layers of **rocks** on both continents
- Similar earth worms living in both South America and South Africa
- **Fossils** found on opposite sides of the Atlantic Ocean were very similar
- Very similar plants and animals that had common ancestors
- Also, the coastline of Africa and South America seem to **fit together** like a jigsaw

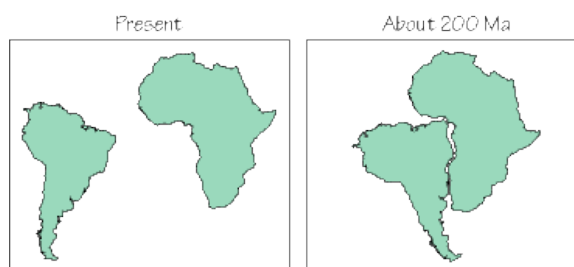

Wegener's Theory did not include any attempt to explain how the continents move and the initial theory was dismissed by scientists at the time.

As far back as the 1930s and developed in the 1960s the idea of convection currents below the crust was researched and finally accepted as the true mechanism for plate tectonics.

### Plate Boundaries

Plate tectonics not only explains why continents move, it also gives rise to **volcanoes and earthquakes**.

There are 3 types of movement between plates: **destructive**, **constructive** and **conservative**.

#### *Destructive Plate Boundary*

At this boundary one plate is **pushed down** into the mantle and melts to form **magma**. This can then create explosive **volcanoes**.

The crust at the ocean floor is **denser** than below the continent. This is why the oceanic crust sinks below the continental crust. This process is called **subduction**.

**Fold mountains** often form along this boundary as well.

**Igneous rock** forms when the molten rock from volcanoes cools and solidifies.

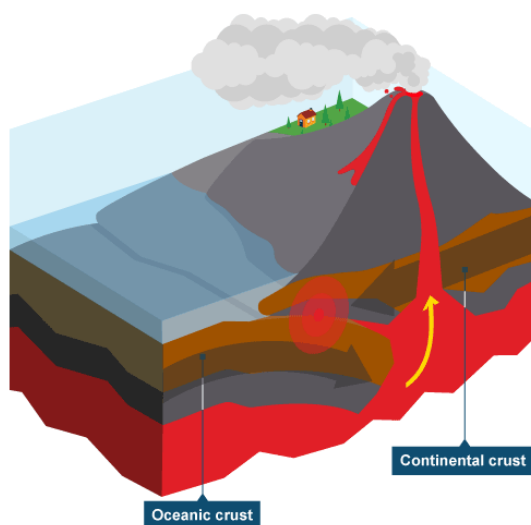

#### *Constructive Plate Boundary*

Plates can move apart from each other. When this happens molten rock (**magma**) from below the surface is released.

This can **cool** and form new **igneous rock**.

If this happens under pressure a volcanic explosion can occur.

If this occurs at a **mid-ocean ridge** new **islands** can form. This is how Iceland was formed.



#### *Conservative Plate Boundary*

At a **conservative plate boundary**, plates **slide past** each other.

This is where **powerful earthquakes** can be generated.

**No volcanoes** are present as no rock melting occurs.

The San Andreas Fault in California is an example of this kind of boundary. A lot of architecture must incorporate earthquake-proofing.

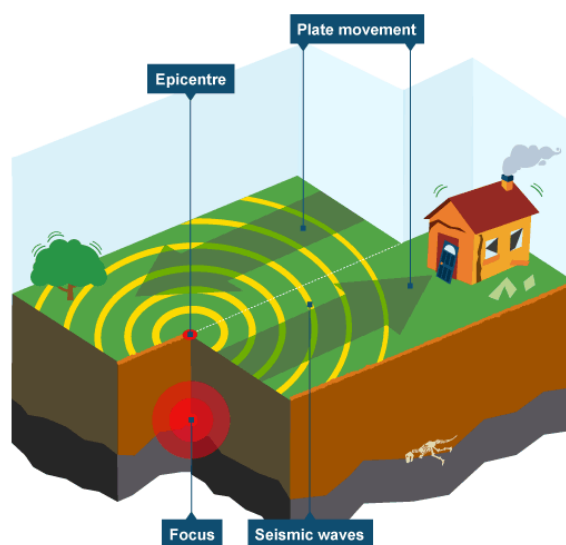

## The Atmosphere

### Creation of the Atmosphere

The air was very different 4,000 million years ago. Most scientists agree that the initial atmosphere came from volcanoes.

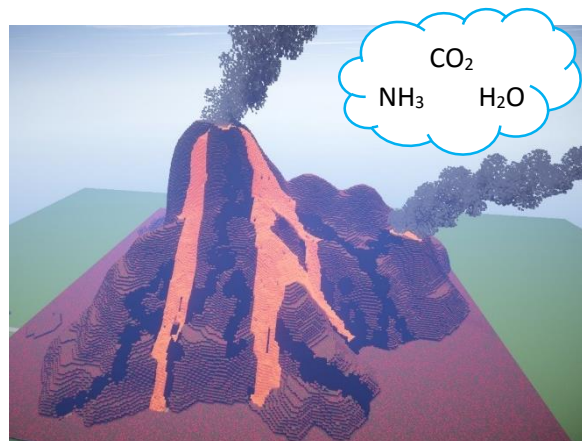

1. Volcanoes released **carbon dioxide**, **ammonia** and **water vapour** (steam), creating the first atmosphere.
2. As the Earth cools the steam **condenses** to form oceans. This occurred very quickly. All other changes took far longer.
3. **Photosynthesising bacteria** form in the oceans. As bacteria **consume  $\text{CO}_2$** , levels in the atmosphere decrease.
4. This bacteria releases oxygen in the atmosphere.  **$\text{O}_2$  levels increase.**
5. Oxygen reacts with ammonia – thus **nitrogen** is formed.  $\text{N}_2$  is the most abundant gas in the atmosphere.
6.  $\text{O}_2$  combines to form  $\text{O}_3$  (**ozone**). Ozone prevents ultraviolet light from entering the Earth and forms a protective layer which helps prevent skin cancer.

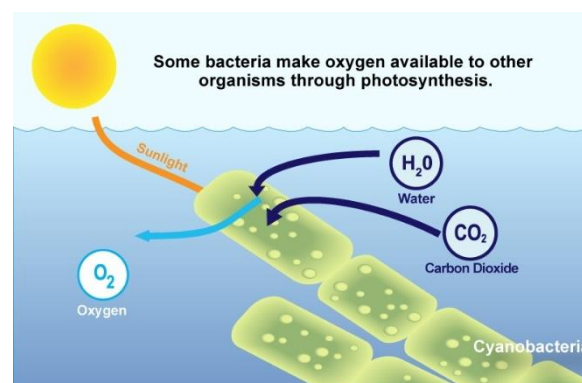

### Current Composition

As green plants evolved, **photosynthesis** has been **consuming** the original **carbon dioxide** from initial atmosphere.

**Evolution** of marine animals has locked carbon dioxide into **limestone** and **chalk** from their **shells**.

More carbon dioxide was locked into **fossil fuels** from the remains of marine organisms and larger land plants.

### Current composition:

- Nitrogen 78%
- Oxygen 21%
- Argon (plus other noble gasses) 0.9%
- Carbon dioxide 0.04%

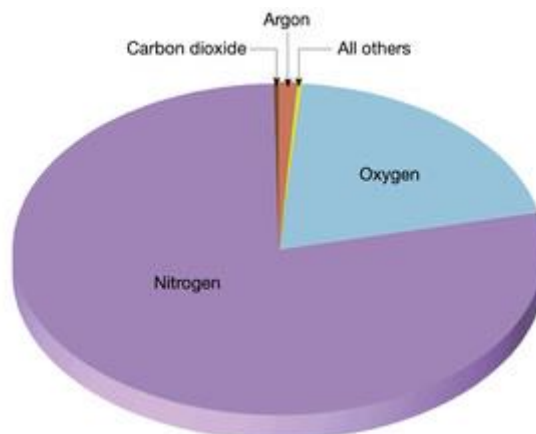

### Respiration, Combustion and Photosynthesis

The composition of the atmosphere has remained **stable** for many millions of years.

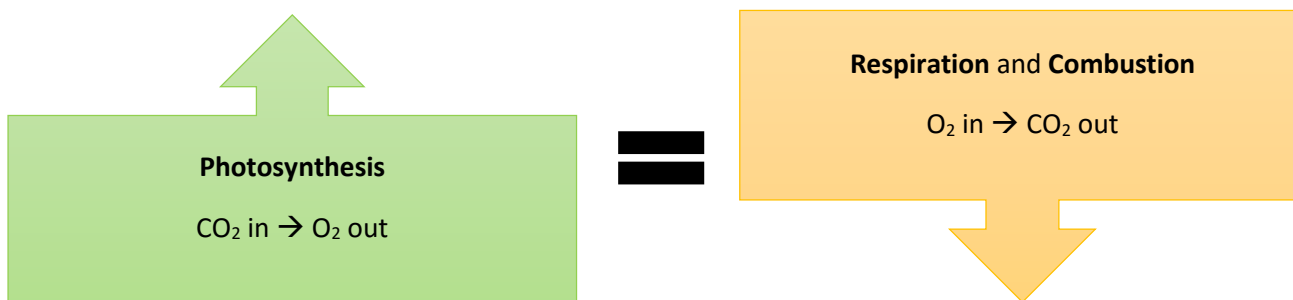

In the past hundred years, humans have **increased combustion** by **burning fossil fuels** and **decreased photosynthesis** due to **deforestation**.

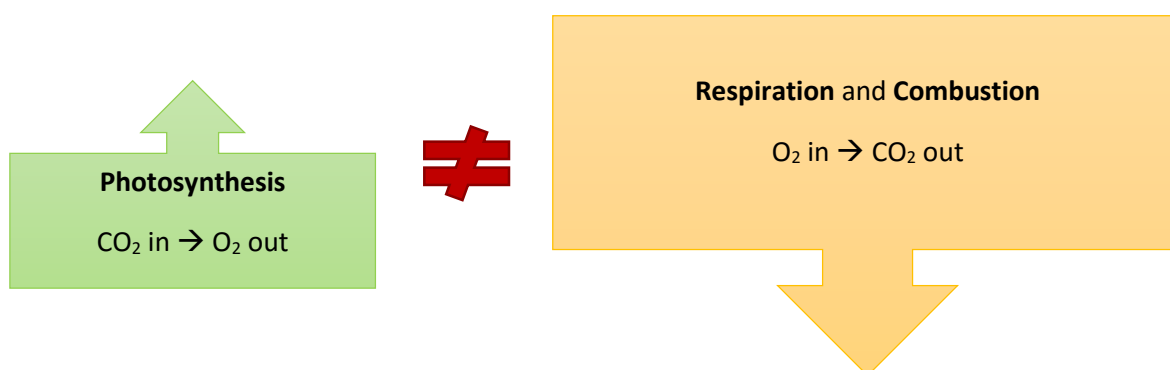

### Environmental issues

#### Carbon dioxide

Due to the emission of increased levels of carbon dioxide, this has led to **higher temperature** of the Earth and therefore **global warming**.

Carbon dioxide acts like a “cushion” around the globe, **preventing heat from escaping**.

Global warming can cause:

1. **Changing weather patterns** e.g. drier, hotter summers in some parts of the world leading to drought
2. **Flooding** due to increased rainfall in some areas
3. Quicker **melting** of ice caps and glaciers
4. **Rising sea levels**



#### Carbon capture

Scientists are thinking of **storing** the CO<sub>2</sub> produced by burning fossil fuels under the sea or underground in geological formations. There are **no simple solutions** to the environmental problems of burning fossil fuels. The best way to reduce CO<sub>2</sub> emission is to become **‘responsible consumers’** of energy and utilise alternative energy sources.

### Sulfur dioxide

Sulfur dioxide forms from burning **impurities** within fossil fuels. Sulfur dioxide within the atmosphere forms sulfuric acid on contact with water (i.e. **acid rain**).

“Clean rain” has a pH  $\approx$  5.5 whilst acid rain has a pH in the range of 2-4.

Acid rain **lowers the pH** of lakes, rivers and ponds etc. causing damage to aquatic life and damaging forests and vegetation. Buildings made of limestone are susceptible to damage by acid rain. Acid rain also increases the rate of corrosion of metal structures such as bridges and statues.



### Sulfur scrubbing

Exhaust flue gasses of fossil fuel plants are filtered and the process of removing sulfur dioxide occurs within the chimneys.

### Gasses

We can test for some of the main gasses that are in the atmosphere with the following tests:

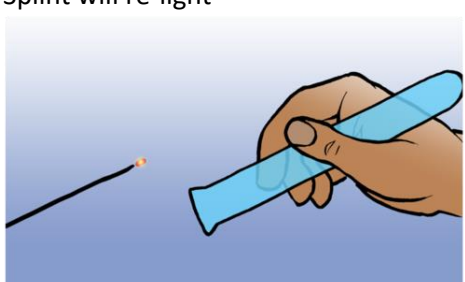
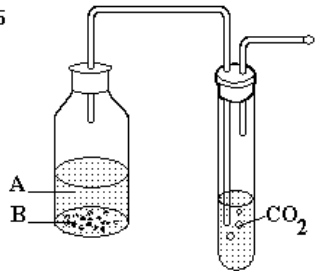
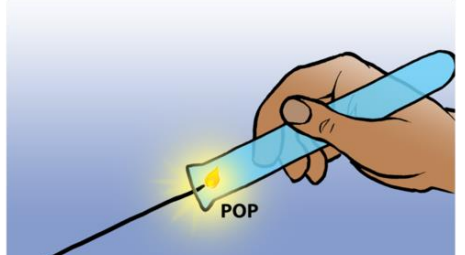
Gas	Test	Positive result
Oxygen	Glowing splint	Splint will re-light 
Carbon dioxide	Bubble through lime water	Lime water will turn cloudy 3.35 
Hydrogen	Lit splint	“Squeaky pop” and the gas will burn 

## Topic 5 – Rate of Chemical Change

### Rates of Reaction

**Rates** of reaction means the **speed** of a reaction. There are 4 ways to increase the rate of the reaction.

1. Temperature
2. Concentration (pressure)
3. Surface area (size)
4. Catalyst

Generally the quicker a reaction the more **profitable** it is, but there are other factors to consider; **energy** requirements, availability, work area and the market are just a few.

**Rate of reaction means how much product is produced within a certain amount of time.**

We can measure the rate by **measuring** the amount of **product** produced (mass or volume) in a certain amount of time. By looking at the **gradient** of a graph we can work out the rate.

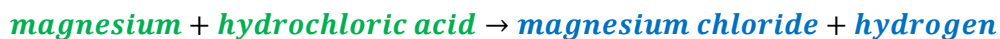

### Reactants

The substances that react together.

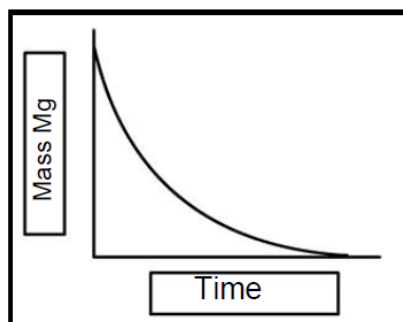

The reactants are used up

### Products

The substances that are produced.

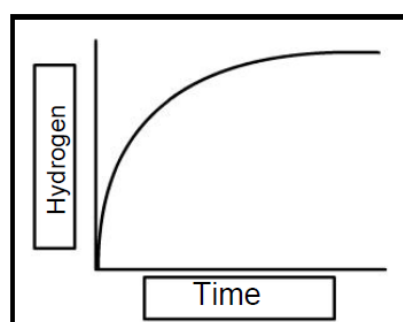

The products form

The **steeper** the gradient the **quicker** the reaction. A **flat line** shows the reaction has **stopped**.

We can use the following formula to calculate the rate:

$$\text{rate of reaction} = \frac{\text{amount of reactant used or amount of product formed}}{\text{time}}$$

## Collecting Data/Measuring the Reaction

The three main methods to collect this data are:

### 1. Collecting gas and measuring its volume

- ⇒ Using a gas syringe to measure the volume. This can be an **accurate** measurement due to the **resolution** of the syringe.
- ⇒ Using a **stopwatch** to measure the time but allows **human** reaction to **reduce** the **accuracy**.
- ⇒ If the reaction is too quick, it may blow the plunger out of the end of the syringe.

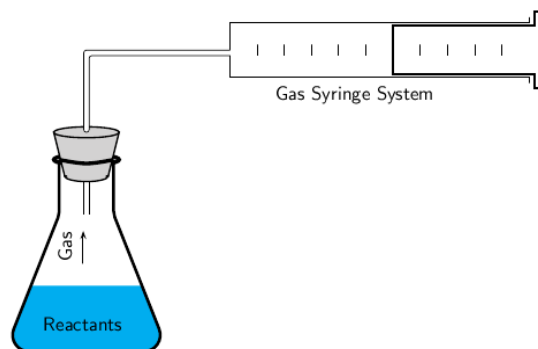

### 2. Measuring change of mass during a reaction (gas given off)

- ⇒ Carry out the reaction on a mass balance
- ⇒ As gas is released the “disappearing” mass can be read
- ⇒ This is the **most accurate** of the three methods as balances tend to have **high resolution**.
- ⇒ Disadvantage: gas is released straight into the room.

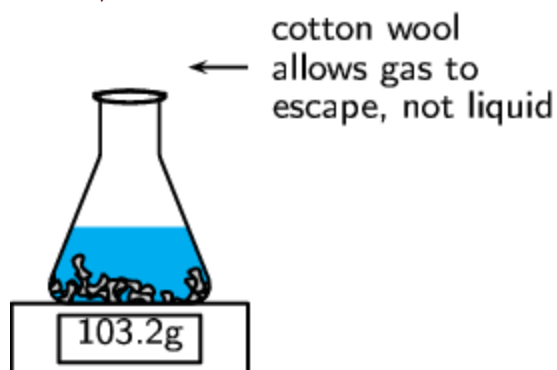

### 3. Measuring the precipitation

- ⇒ Precipitates cause “cloudiness” within a solution.
- ⇒ If we observe a mark through the solution, we time how long it takes for it to disappear.
- ⇒ This only works where the initial solution is see-through.
- ⇒ This method is **subjective** and can be **inaccurate**. Many people will disagree at the exact point when the mark “disappears”.

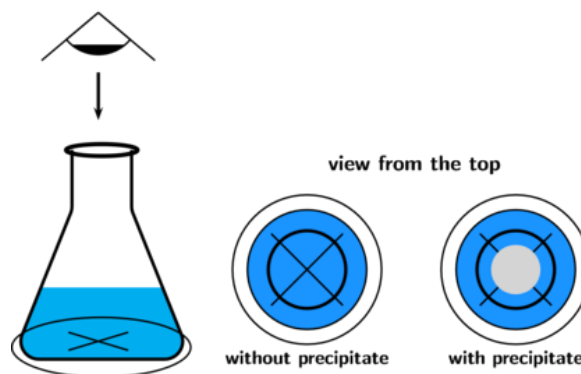

### Particle/Collision Theory

Particles must **collide** with **enough energy** in order to react – these are called **successful collisions**.

#### Temperature

When **temperature** is **increased** particles all move **quicker** i.e. they have more **kinetic energy**. If they are moving quicker they will cause more successful collisions.

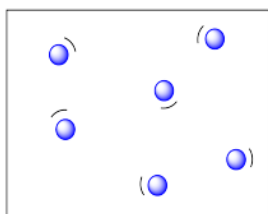

Cold – less energy

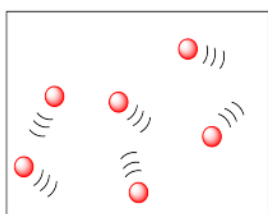

Hot - more energy

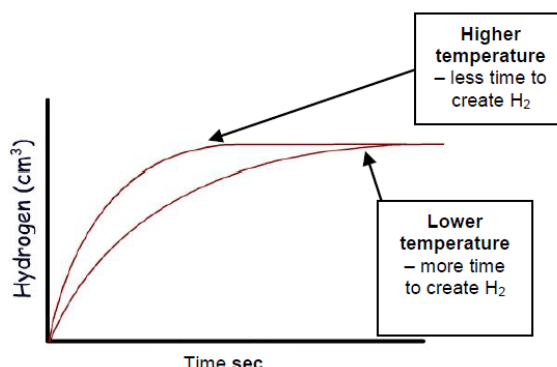

#### Concentration (Pressure)

If a solution is made **more concentrated**, that means there are **more reactant particles** in between the water molecules which makes successful collision more likely.

In a gas, **increasing the pressure** means the particles are **closer together** and then successful collision will be more likely.

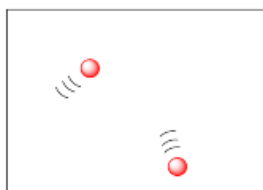

Low concentration

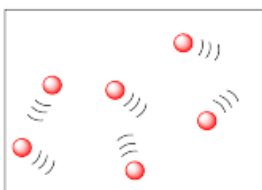

High concentration

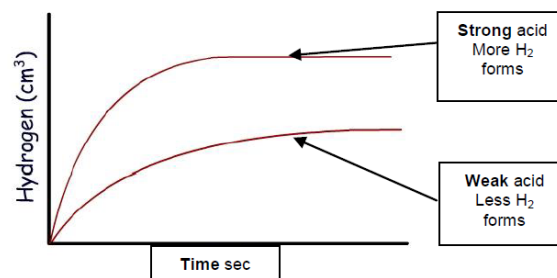

#### Surface Area (Size)

Breaking a solid into **smaller pieces** will **increase the total surface area**. This means particles in the solution will have more area to react with and therefore more successful collisions.

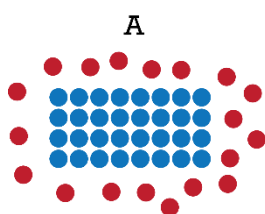

Small surface area

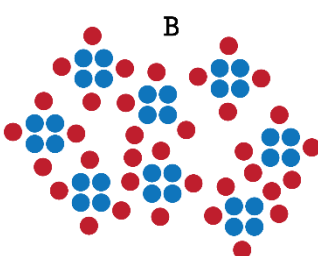

Large surface area

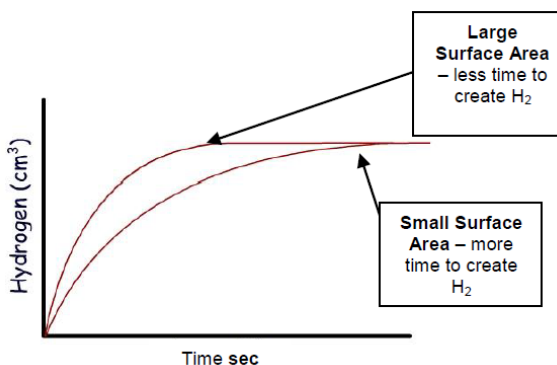

## Catalysts

**A catalyst is a substance which increases the speed of reaction without being chemically changed or used up in the reaction.**

- ⇒ A catalyst works by giving the reactants surface to stick to where they can “bump” into each other. The **overall number** of collisions **isn't increased** but the **number of successful collisions is**.
- ⇒ Development of better catalysts is **extremely important in industry** as it can lead to new ways of making materials that may use **less energy**, use renewable raw materials or use fewer steps.
- ⇒ Catalysts allow reactions to work at a much **lower temperature**, which reduces **energy consumption**.
- ⇒ Different reactions require different catalysts.
- ⇒ Catalysts can be **expensive**, need to be removed from the reaction and can be “poisoned” by impurities.
- ⇒ **Enzymes** are biological catalysts.

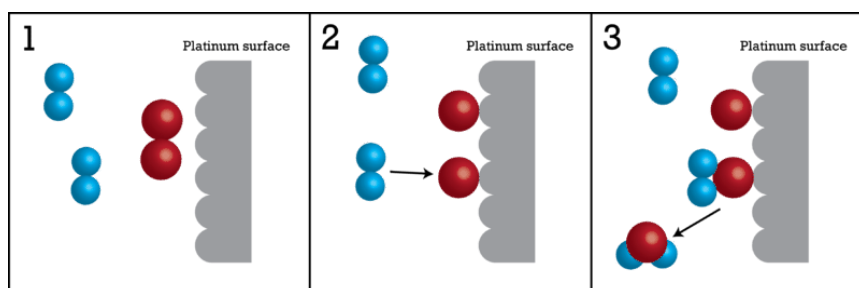

*In this example platinum acts as a catalyst for the reactants.*

### Activation Energy

Activation energy represents the **minimum energy** needed by the reactants needed to **break their bonds**.

**A catalyst reduces the activation energy.** It provides an alternative pathway for the reaction.

The overall energy change ( $\Delta H$ ) remains the same for the reaction.

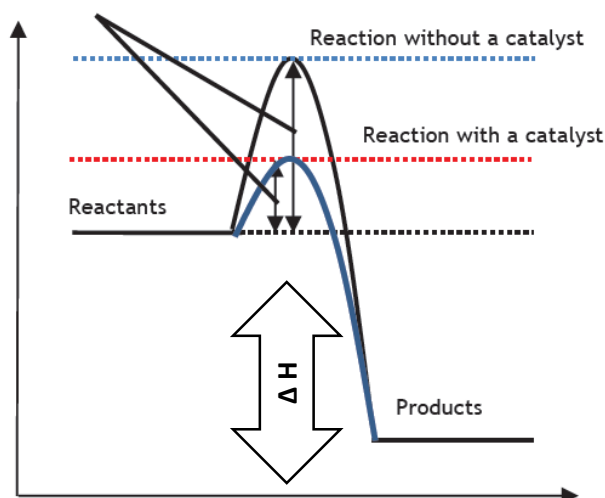

### Energy transfer in reactions

In an **exothermic** reaction energy is transferred to its surroundings, usually in the form of heat and shown by a **rise in temperature**.

In an **endothermic** reaction energy is taken in from its surroundings, usually in the form of heat and shown by a **fall in temperature**.